

AC NO: 70/7460-1C

DATE: 12/11/73



ADVISORY CIRCULAR

DEPARTMENT OF TRANSPORTATION FEDERAL AVIATION ADMINISTRATION

SUBJECT: OBSTRUCTION MARKING AND LIGHTING

1. PURPOSE. This circular describes the Federal Aviation Administration standards for obstruction marking and lighting.
2. CANCELLATION. This circular cancels and supersedes Advisory Circular 70/7460-1B dated October 1, 1972.
3. EXPLANATION OF REVISIONS. Describes existing standards in a simplified format. Establishes new standards for lighting all types of structures with high intensity white obstruction lights. The recommendation for day marking is deleted when this type of light is displayed. Provides for back lighting the support structures of catenaries and thereby deletes the requirement for day marking this side. Sets standards for determining width of alternately painted bands on structures exceeding 700 feet (210m) above site level. Describes marking and lighting standards for moored balloons and kites.

The United States customary units of measurement are gradually being replaced by the metric system. Recognizing this trend, we consider it important to prepare for broader use of the metric system. Therefore, for information purposes, metric units have been included in parenthesis next to the English units throughout the text. The metric values are based upon the International Civil Aviation Organization's standard English/metric equivalents rounded off (30 meters equals 100 feet) and, therefore, do not represent exact conversions of the English values. The English values should be used in applying the standards contained in this advisory circular. This does not involve any change in standard dimensions, tolerances or performance specifications.

Initiated by: AAT-240

12/11/73

AC 70/7460-1C

TABLE OF CONTENTS

	<u>Page No.</u>
CHAPTER 1. INTRODUCTION	1
1. Purpose	1
2. Objective	1
3. Federal Communications Commission Specifications	1
CHAPTER 2. GENERAL RECOMMENDATIONS	3
4. Objects to be Marked and Lighted	3
5. Deviations and Modifications	3
a. Modifications	3
b. Deviations	3
CHAPTER 3. MARKING	5
6. Purpose	5
7. Omission of Standard Marking	5
8. Colors	5
a. Orange Number 12197	5
b. White Number 17875	5
9. Painting	5
a. Materials and Application	5
b. Surfaces Not Requiring Paint	5
c. Skeletal Structures	6
10. Patterns	6
a. Solid Pattern	6
b. Alternate Bands of Orange and White	6
c. Checkerboard Pattern	6
d. Beachball Pattern	7
	8
11. Markers	8
a. Spherical Markers	8
b. Flag Markers	8
	9
12. Special Markings	9
CHAPTER 4. GENERAL APPLICATION OF LIGHTING	11
13. Purpose	11
14. Colors	11
a. Aviation Red Obstruction Lights	11
b. High Intensity White Obstruction Lights	11
c. Dual Lighting	11
	11

	<u>Page No.</u>
15. Application	11
a. Heights	11
b. Determining Number of Light Levels	11
c. Adjacent Structures	12
d. Shielded Lights	12
e. Temporary Warning Lights	12
f. Nonstandard Lights	12
g. Hazard Areas	12
h. Monitoring of Obstruction Lighting	12
i. Cleaning	13
j. Lamp Types	13
k. Notification of Light Failure	13
l. Interference	13
m. Manufacturers	13
 CHAPTER 5. RED OBSTRUCTION LIGHTING STANDARDS	 15
16. Standards for Lighting Obstructions to Air Navigation with Red Obstruction Lights	15
a. Flashing Red Beacon	15
b. Steady Burning Red Obstruction Light	15
c. Rated Lamp Voltage	15
d. Operation of Red Lights	15
e. Availability of Specifications	15
f. Poles, Towers and Similar Skeletal Structures	16
g. Chimneys, Flare Stacks and Similar Solid Structures	17
h. Prominent Buildings and Similar Extensive Obstructions	18
i. Alternate Methods of Displaying Obstruction Lights	19
 CHAPTER 6. HIGH INTENSITY OBSTRUCTION LIGHTING STANDARDS	 21
17. Standards for Lighting Obstructions to Air Navigation with High Intensity White Obstruction Lights	21
a. High Intensity Obstruction Light	21
b. Light Specifications	21
c. Flashtube Replacements	22
d. Installation Guidance	22
e. High Intensity Light Units	23
f. Relocation or Omission of Light Units	24
g. Chimneys, Flare Stacks and Similar Solid Structures	25

	<u>Page No.</u>
h. Radio and Television Towers and Similar Skeletal Structures	25
i. Hyperbolic Cooling Towers	25
j. Supporting Structures of Overhead Transmission (Catenary) Lines	26
k. Prominent Buildings, Observation Towers and Similar Extensive Obstructions	28
CHAPTER 7. DUAL LIGHTING SYSTEMS	31
18. Dual Lighting Systems	31
CHAPTER 8. MARKING AND LIGHTING OF MOORED BALLOONS AND KITES	33
19. Purpose	33
20. Application	33
21. Marking	33
a. Display	33
b. Shape	33
c. Color Patterns	33
22. Lighting	33
a. Display	33
b. Light Distribution	33
23. Light Control Device	34
24. Other Federal or Local Government Regulations	34
CHAPTER 9. OBSTRUCTION MARKING AND LIGHTING EQUIPMENT	35
25. Purpose	35
26. Paint	35
a. Colors	35
b. Availability of Specifications	35
27. Lights and Associated Equipment	35
a. Aviation Red Obstruction Lighting System	35
b. High Intensity White Obstruction Lighting Systems	36
c. Approved Manufacturers	36
d. Installation and Maintenance	36
e. Availability	36
f. Recommended Lamp Equipment	37

Page No.

Standards for Lighting Chimneys and Similar Solid
Obstructions with High Intensity White Obstruction
Lights - Day and Night

Figure 4. 150 feet (45m) to 900 feet (270m) AGL	4
Figure 5. 900 feet (270m) to 1,500 feet (450m) AGL	5
Figure 6. 1,500 feet (450m) to 2,100 feet (630m) AGL	6

Standards for Lighting Towers and Similar Skeletal
Obstructions with High Intensity White Obstruction
Lights - Day and Night

Figure 7. 150 feet (45m) to 900 feet (270m) AGL	7
Figure 8. 900 feet (270m) to 1,500 feet (450m) AGL	8
Figure 9. 1,500 feet (450m) to 2,100 feet (630m) AGL	9

Standards for Lighting Solid and Skeletal Obstructions
with Dual Lighting Systems

Figure 10. 150 feet (45m) to 900 feet (270m) AGL	10
Figure 11. 900 feet (270m) to 1,500 feet (450m) AGL	11
Figure 12. 1,500 feet (450m) to 2,100 feet (630m) AGL	12

CHAPTER 1. INTRODUCTION

1. PURPOSE. To describe recommended standards for the marking and lighting of obstructions as official FAA policy.
2. OBJECTIVE. To provide the most effective means of indicating the presence of obstructions to pilots, in accordance with the Administrator's statutory responsibility for promoting safety in air commerce.
3. FEDERAL COMMUNICATIONS COMMISSION SPECIFICATIONS. The specifications for obstruction marking and lighting antenna structures contained in Part 17 of the Federal Communications Commission Rules and Regulations are identical with the standards contained in this publication.

CHAPTER 2. GENERAL RECOMMENDATIONS

4. OBJECTS TO BE MARKED AND LIGHTED. When any object or portion thereof, either temporary or permanent, exceeds a height of 200 feet (60m) above site level or any standard for determining obstructions set forth in Part 77 of the Federal Aviation Regulations (14 CFR 77), that object should be marked and lighted exactly in accordance with the applicable standards described herein in order to be most conspicuous. An FAA aeronautical study, however, may determine that the absence of such marking and/or lighting will not impair safety to air navigation. The overall height includes all appurtenances such as lights, rods, antennas, etc.
5. DEVIATIONS AND MODIFICATIONS. After an initial determination is made that an object should be marked and lighted, a further determination may be made on whether the marking and lighting can be modified or a deviation from the standards can be concurred in. The final determination for a modification or deviation must be based on a study showing that an acceptable level of safety is achieved.
 - a. Modifications. Modifications may be recommended when, in the opinion of the FAA Regional Director or his designee conducting the study, the proposed modification would provide adequate protection for air commerce. Some examples of modifications are:
 - (1) Marking and/or lighting only a portion of an object. The object may be located with respect to other objects or terrain so that application of the specific marking or lighting standards need be applied to only a portion of it.
 - (2) No marking and/or lighting. The object may be so located with respect to other objects or terrain, so removed from the general flow of air traffic, or so conspicuous by its shape, size or color that marking or lighting would serve no useful purpose.
 - (3) Marking or lighting an object in accordance with the standards for an object of greater height or size. The object may present such a potential hazard that higher standards are recommended to ensure the safety of air navigation.
 - (4) Other similar situations.
 - b. Deviations. Deviations may be permitted with the coordinated approval of the Director, Air Traffic Service. Some examples of deviations are changes in:

CHAPTER 3. MARKING

6. **PURPOSE.** The purpose of marking a structure is to warn airmen of its presence during daylight hours. To accomplish this objective, it may be necessary to color the structure or indicate its presence by use of suitable markers, flags or lights.
7. **OMISSION OF STANDARD MARKING.** When high intensity lighting systems are employed in accordance with the standards contained herein, the marking of structures with standard aviation surface orange and white paint and red obstruction lights may be omitted.
8. **COLORS.** Maximum visibility of an obstruction by contrast in colors can best be obtained by the use of aviation surface orange and white paint. Orange or white enamel paint may be used for marking, provided its chromaticity and luminance factors satisfy Federal Standards FED-STD 595, color, as follows:
 - a. **Orange Number 12197** (Aviation Surface Orange).
 - b. **White Number 17875** (Aviation White).
9. **PAINTING.** The specifications of surface colors apply only to freshly painted surfaces. Paints used for surface markings usually change with time. While it is not feasible to require strict maintenance, surfaces should be repainted whenever the color changes noticeably or its effectiveness is impaired by scaling or chipping.
 - a. **Materials and Application.** Quality paint materials should be selected to be compatible with the surfaces to be painted, including previous coatings on the surfaces if any, as well as suitable for the environmental service conditions to which it will be subjected. Surface preparation and paint application should be accomplished in accordance with the manufacturer's recommendations as appropriate for the paint to be used and surface to be coated.
 - b. **Surfaces Not Requiring Paint.** If the smooth surface of paint on the ladders, decks and walkways of certain types of steel towers and similar structures presents a potential danger to maintenance personnel, such surfaces need not be painted. Care should be taken so the overall marking effect of the painting is not reduced. Where the painting or the act of painting certain precision or critical surfaces would have an adverse effect on the desired transmission or radiation characteristics of a radio frequency signal, such painting may be omitted.

- c. Skeletal Structures. Paint should be applied to all surfaces, both inner and outer, of the framework, in order to be effective.
10. PATTERNS. Patterns of various types are used to mark obstructions to air navigation. Normally, the size and shape of the obstruction will determine the pattern to be used.
- a. Solid Pattern. An obstruction having a projection on any vertical plane of less than 10.5 feet (3.2m) in both dimensions, should be colored aviation surface orange.
 - b. Alternate Bands of Orange and White. Alternate bands of aviation surface orange and white are normally displayed on the following structures:
 - (1) Towers.
 - (2) Poles.
 - (3) Smokestacks.
 - (4) Skeletal framework of storage tanks and similar structures.
 - (5) Structures which appear narrow from a side view.
 - (a) Width of Bands. The width of bands for structures of any height should be equal, provided that each band has a width of not more than 100 feet (30m) nor less than one and one-half feet (0.5m). The bands should be perpendicular to the vertical axis of the obstruction with the bands at each end colored orange. The width of each band for structures as high as 700 feet (210m) above ground level (AGL) should be approximately one-seventh of the height of the structure. Higher structures should be painted an additional orange and white band for each additional 200 feet (60m) of height, or fraction thereof, with the width of all bands equal and in proportion to the structure's height above ground level. For example if a structure is:

<u>Greater Than</u>	<u>But Not Exceeding</u>	<u>Band Width</u>
10.5 feet (3.2m)	700 feet (210m)	1/7 of height of structure
700 feet (210m)	900 feet (270m)	1/9 of height of structure
900 feet (270m)	1,100 feet (330m)	1/11 of height of structure
1,100 feet (330m)	1,300 feet (390m)	1/13 of height of structure

If the top of the structure has a cover or roof, the top orange band should be continued to cover the entire top of the structure. If the object under study is a flag-pole, skeletal structure or similar object erected on top of a building, the combined height of the object and building will determine whether marking is recommended; however, only the height of the object under study determines the width of the color bands.

- (b) Partial Marking. If marking is recommended on only a portion of a structure because of shielding by other objects or terrain, the width of the bands should be determined by the overall height of the structure. A minimum of three bands should be displayed on the upper portion of the structure.
- c. Checkerboard Pattern. Checkerboard patterns of alternate rectangles of aviation surface orange and white are normally displayed on:
- (1) Water, gas and grain storage tanks, excluding skeletal framework.
 - (2) Buildings.
 - (3) Structures which appear broad from a side view, such as structures having a horizontal dimension 10.5 feet (3.2m) or greater and this horizontal dimension is equal to or greater than the vertical dimension.
- (a) Size of Rectangles. The sides of the checkerboard rectangles should measure not less than five feet (1.5m) nor more than 20 feet (6m). However, if it is impracticable because of the size or shape of a structure, the rectangle may have sides less than five feet (1.5m), provided their dimensions remain as close as practicable to the five-foot (1.5m) minimum. When possible, corner surfaces should be colored orange. If it is technically impracticable to color the roof of a structure in a checkerboard pattern, such roof may be colored orange. If part or all of a spherical shaped structure does not permit the exact application of a checkerboard pattern, then the shape of the new rectangles may be modified to fit the shape of the spherical surface.

12/11/73

- (b) Exceptions. If the type construction of storage tanks does not permit coloring by a checkerboard pattern, then such obstructions should be colored by alternate bands of orange and white, or a limited checkerboard pattern applied to the upper one-third of the structure, provided an aeronautical study indicates that the modified marking will provide adequate protection for air navigation.
- d. Beachball Pattern. Spherical shaped water storage tanks with a single circular standpipe support may be colored in the beachball striped pattern, as shown in Appendix 1, Fig. 5. The tank should be colored to show alternate stripes of aviation surface orange and white. The stripes should extend from the top center of the tank to its supporting standpipe.
- (1) Width of Stripes. The width of the stripes should be equal and the width of each stripe at the greatest girth of the tank should not be less than five feet (1.5m) nor more than 15 feet (4.5m).
- (2) Community Name. If it is desirable to paint the name of the community on the side of the tank, the stripe pattern may be broken to serve this purpose. This open area should have a maximum height of three feet (0.9m).
11. MARKERS. Markers should be used to mark obstructions when it has been determined that it is impracticable to mark such obstructions by painting. Markers may also be used in addition to aviation surface orange and white colors when it has been determined that such markings should be used to provide protection for air commerce. They should be displayed in conspicuous positions on or adjacent to the obstruction so as to retain the general definition of the obstruction. They should be recognizable in clear air from a distance of at least 1,000 feet (300m) in all directions from which an aircraft is likely to approach. They should be distinctively shaped so they are not mistaken for markers that are used to convey other information. The shape should be such that the hazard they mark is not increased.
- a. Spherical Markers. Spherical markers are normally displayed on overhead wires. Markers may be of another shape, provided the projected area of such markers will not be less than that presented by a spherical marker.
- (1) Display. At least one such marker should be displayed at equal intervals for each 150 feet (45m), or fraction thereof, of the overall length of the overhead line and not lower than the highest wire. The distance between markers may be increased to not more than 600 feet (180m) when the overhead wires are

located more than 15,000 feet (450m) from the nearest landing area. Where there is more than one overhead wire on which the spheres can be installed, the spheres may be installed alternately along each wire as long as the distance between adjacent spheres meets the spacing standard. This allows the weight and wind loading factors to be distributed.

- (2) Size and Color. The diameter of the markers should not be less than 20 inches (0.5m) and should be colored aviation orange.
- b. Flag Markers. Flags may be used to mark obstructions when it has been determined that the use of coloring or spherical markers is technically impracticable.
- (1) Display. Flag markers should be displayed around, on top of the obstruction or around its highest edge. When flags are used to mark extensive obstructions or closely grouped obstructions, they should be displayed approximately 50 feet (15m) apart.
 - (2) Shape. Flags should be rectangular in shape and have stiffeners to keep them from drooping in calm wind. The flag stakes should be of such strength and height that they will support the flags free of the ground, vegetation or nearby surfaces.
 - (3) Color Patterns. Flags should be in one of the following patterns:
 - (a) Solid color aviation surface orange not less than two feet (0.6m) on a side.
 - (b) Two triangular sections, one of aviation surface orange and the other of aviation surface white, combined to form a rectangle not less than two feet (0.6m) on a side.
 - (c) A checkerboard pattern of aviation surface orange and aviation surface white squares, each one foot (0.3m) plus or minus ten percent on a side, combined to form a rectangle not less than three feet (0.9m) on a side.
12. SPECIAL MARKINGS. Vehicles customarily used on landing areas should be marked in accordance with the provisions of Advisory Circular 150/5210-5, Painting, Marking and Lighting of Vehicles Used on an Airport. The FAA may also recommend appropriate marking in an area where obstructions are so grouped as to present a common hazard to air commerce.

CHAPTER 4. GENERAL APPLICATION OF LIGHTING

13. PURPOSE. The purpose of lighting a structure is to warn airmen of its presence during both daytime and nighttime conditions. To be most effective, the lighting standards herein should be adhered to exactly as described.
14. COLORS. Red obstruction lights may be used during the hours of darkness, during periods of limited daytime illuminance and/or reduced meteorological visibility. High intensity white lights may be used for both daytime and nighttime conditions. Obstruction lighting may be displayed on structures in any of the following combinations:
 - a. Aviation Red Obstruction Lights. Flashing aviation red beacons and steady burning aviation red lights during nighttime operation. Aviation orange and white paint should be used for daytime marking.
 - b. High Intensity White Obstruction Lights. Flashing high intensity white lights during daytime with reduced intensity for twilight and nighttime operation. When this type system is used, the marking of structures with red obstruction lights and aviation orange and white paint may be omitted.
 - c. Dual Lighting. A combination of flashing aviation red beacons and steady burning aviation red lights for nighttime operation and flashing high intensity white lights for daytime operation. Aviation orange and white paint may be omitted.
15. APPLICATION. Whenever obstruction lights are displayed on any structure, they should be of sufficient intensity and installed in a manner that will attract the attention of pilots approaching the obstruction from any normal angle while at any altitude up to 1,500 feet (450m) above the obstruction. Obstruction lighting may be displayed in addition to marking (paint) for daytime operation provided such lights more adequately warn airmen of the obstruction. The following factors should be considered when determining the placement of obstruction lights on a structure:
 - a. Heights. All heights referred to herein pertain to the obstruction's height above ground level or water, if so situated.
 - b. Determining Number of Light Levels.
 - (1) Red Obstruction Lighting Systems. The overall height of the structure including all appurtenances such as rods, antennas, obstruction lights, etc., is used to determine the number of levels of lights. The top level of lights should be installed on the highest point.

12/11/73

- (2) High Intensity Lighting Systems. The overall height of the main structure, excluding all appurtenances, is used to determine the number of levels of lights. The top level of lights should be installed on the highest portion of the main structure. In addition, a white omnidirectional beacon should be displayed on the highest portion of any antenna or other appurtenance supported by the main structure.
- c. Adjacent Structures. The elevation of the tops of the buildings in closely built up areas may be used as the equivalent of the ground level when determining the proper number of lights necessary to adequately mark an obstruction.
- d. Shielded Lights. If any light is shielded by an adjacent object, additional lights should be mounted on that object to retain the general definition of the obstruction. However, the additional lights may be omitted if they do not contribute to the definition of the obstruction.
- e. Temporary Warning Lights. When an obstruction to air navigation is presented during construction of a structure, temporary lights should be installed at the uppermost point of the structure. In addition, as the height of the structure progresses above the level at which permanent obstruction lights will be required, either temporary or permanent lights should be installed at such levels. Temporary lights should be displayed from sunset to sunrise until all of the permanent lights are in operation. The lights should be positioned so as to ensure unobstructed visibility of at least one light at each level from aircraft at any normal angle of approach.
- f. Nonstandard Lights. Chimneys and similar obstructions may be flood-lighted by fixed searchlight projectors installed at three or more equidistant points around the base of each obstruction. The searchlight projectors should provide an average illumination of at least 15 footcandles over the top one-third of the obstruction.
- g. Hazard Areas. An area in which a visible or invisible hazard exists or is proposed should be lighted as prescribed by FAA. This lighting would be in addition to such lighting as may be necessary on any natural or man-made obstruction located within the area.
- h. Monitoring of Obstruction Lighting. Obstruction lighting should be visually observed at least once each 24 hours. In the event obstruction lighting is not readily accessible for visual observation, a properly maintained automatic visual or audible alarm indicator should be installed and operated to provide an indication that such lights are functioning properly as required. This alarm indicator

should be designed to register any malfunction of any light on the obstruction regardless of its position. The automatic monitoring alarm indicator should be located in an area generally occupied by facility personnel. In some cases, this may require relocating the monitor to a remote control station.

- i. Cleaning. All lights, and particularly the top level, should be readily accessible to enable cleaning when necessary and to facilitate lamp/flashtube replacement. The lights should be kept clean to prevent a reduction in light output. They should be cleaned on a scheduled basis to prevent residue from accumulating on the face of the light unit and to prevent crusting due to the lamp heat.
- j. Lamp Types. Only lamps of the type recommended in Para. 27.f. should be used in the light fixtures.
- k. Notification of Light Failure. Any observed or otherwise known extinguishment or improper functioning of any flashing obstruction light, regardless of its position on a natural or man-made obstruction, which will last more than 30 minutes, should be immediately reported. Such reports should be made by telephone or telegraph to the nearest flight service station or office of the FAA and should set forth the condition of the light, or lights, the circumstances which caused the failure and the probable date the normal operation will be resumed. Further notification by telephone or telegraph should be given immediately upon resumption of normal operation of the light, or lights.
- l. Interference. Where obstruction lights might present a problem to the safe operation of aircraft (landing or departing), railway trains, motor vehicles and surface vessels, or if the lights might be a source of irritation to residents, consideration should be given to mitigating or eliminating the adverse effects of the lights. Shielding of lights should be considered, steady burning lights may be made to flash, or the lower level of lights may be extinguished provided the hazard to air navigation is not increased. The FAA Regional Director or his designee is responsible for assuring that such obstruction lighting installations are fully coordinated with all parties concerned and that proper corrective measures are placed in effect. In the case of a navigable waterway, the light installation must be coordinated with the Commandant, U. S. Coast Guard, to avoid interference with marine navigation.
- m. Manufacturers. The names of qualified manufacturers and a description of their equipment are listed in the FAA Advisory Circular 150/5345-1, Approved Airport Lighting Equipment. See Chapter 9.

CHAPTER 5. RED OBSTRUCTION LIGHTING STANDARDS

16. STANDARDS FOR LIGHTING OBSTRUCTIONS TO AIR NAVIGATION WITH RED OBSTRUCTION LIGHTS.
- a. Flashing Red Beacon. This 300 mm flashing beacon consists of two simultaneously flashing incandescent lamps of at least 620 watts with aviation red color filters. The steady burning intensity should be not less than 2,000 candelas (in red). The flashing mechanism should produce not more than 40 flashes per minute nor less than 12 flashes per minute with a period of darkness equal to approximately one-half the luminous period. If the obstruction is located within 15,000 feet (4,500m) of a landing area, the flashing frequency should be not less than 20 flashes per minute. These beacons should conform to FAA Specification CAA 446, or Military Specification L-6273.
 - b. Steady Burning Red Obstruction Light. This obstruction light consists of one or more steady burning lamps of at least 116 watts (when used in multiple circuit), enclosed in an aviation red obstruction light globe. The intensity should be not less than 32.5 candelas. If the flashing mechanism is installed so as to make it necessary for these lights to flash, the simultaneous flashing of all lights will be permissible. These lights should conform to FAA Specification AC 150/5345-2 (L-810), or Military Specification L-7830.
 - c. Rated Lamp Voltage. The rated voltage of the lamp should, in each case, be not more than three percent higher than the average voltage across the lamp measured at the lamp socket with the lamp operating during the hours of normal operation.
 - d. Operation of Red Lights. Red obstruction lights should be operated by a satisfactory control device adjusted so the lights will be turned on when the north sky illuminance falls on a vertical surface to a level of not less than 35 footcandles. They should also be turned on during daytime when the flight visibility is restricted. In Alaska, however, the lights should be turned on during daytime when a prominent unlighted object cannot be seen from a distance of three statute miles. The control device should turn off the lights when the north sky illuminance rises to a level of not less than 58 footcandles, or the lights may remain on continuously.
 - e. Availability of Specifications.
 - (1) FAA Specifications CAA 446 and AC 150/5345-2 (L-810) are available free of charge from the Department of Transportation. See Chapter 9.

- (2) Military Specifications L-6273 and L-7830 are available free of charge from the Naval Publications and Forms Center. See Chapter 9.

f. Poles, Towers and Similar Skeletal Structures.

(1) Top Mounted Obstruction Light.

(a) Structures Not More Than 150 Feet (45m) AGL. Two or more steady burning lights should be installed in a manner to ensure unobstructed visibility of one or more lights from an aircraft at any normal angle of approach.

(b) Structures Exceeding 150 Feet (45m) AGL. At least one 300 mm flashing beacon should be installed in a manner to ensure unobstructed visibility from an aircraft at any normal angle of approach.

(c) Special Cases.

1. Appurtenances Not Exceeding 20 Feet (6m). If a rod, antenna or other appurtenance of not more than 20 feet (6m) in height is incapable of supporting a beacon and it is determined that this appurtenance does not allow unobstructed viewing of a single 300 mm flashing beacon from any normal angle of approach, there should be installed two such beacons properly positioned on top of the main structure to permit unobstructed viewing of at least one beacon.

2. Appurtenances Exceeding 20 Feet (6m). If a rod, antenna or other appurtenance greater than 20 feet (6m) in height is incapable of supporting a beacon, a supporting mast with one or more beacons should be installed adjacent to the appurtenance and to a height within 20 feet (6m) of the tip of the appurtenance so as to permit unobscured viewing of at least one beacon.

(2) Mounting Intermediate Levels. The number of levels of lights may be obtained from Appendix 2, Figs. 1-3. The number of lights on each level is determined by the shape and height of the structure. These lights should be mounted so as to ensure unobstructed viewing of at least one light from any normal angle of approach.

(a) Steady Burning Lights.

1. If the structure is not more than 450 feet (135m) in height, two or more steady burning lights should be installed on diagonally or diametrically opposite positions.

2. If the structure exceeds 450 feet (135m) in height, steady burning lights should be installed on each outside corner of each level.

(b) Flashing Beacons.

1. Normally, structures not more than 450 feet (135m) in height do not require intermediate levels of flashing beacons.
2. If the structure is more than 450 feet (135m) in height, a flashing beacon should be installed within the structure proper. If the structural members impair the viewing of the beacon, then two beacons should be mounted on the outside of diagonally or diametrically opposite positions of each level.

g. Chimneys, Flare Stacks and Similar Solid Structures.

(1) Top Mounted Obstruction Lights.

- (a) Structures Not More Than 150 Feet (45m) AGL. At least three steady burning obstruction lights should be installed at regular intervals on the horizontal plane at or near the top, in a manner to ensure unobstructed visibility of at least two lights from aircraft at any normal angle of approach.
- (b) Structures Exceeding 150 Feet (45m) AGL. Two or more 300 mm flashing beacons should be installed in a manner to ensure unobstructed visibility from an aircraft at any normal angle of approach.
- (c) Chimneys. Lights may be displayed from five (1.5m) to 10 feet (3m) below the top of chimneys to avoid the obscurant effect of the deposits generally emitted by this type of structure. It is important that these lights be readily accessible to enable cleaning when necessary and to facilitate lamp replacements.

(2) Mounting Intermediate Levels.

- (a) Steady Burning Lights. The number of light levels may be obtained from Appendix 2, Figs. 1-3. At least three lights should be installed on each level. These lights should be mounted so as to ensure unobstructed viewing of at least two lights on each level.

12/11/73

- (b) Flashing Beacons. The number of beacon levels may be obtained from Appendix 2, Figs. 1-3.
1. Normally, structures not more than 450 feet (135m) in height do not need intermediate levels of flashing beacons.
 2. If the structure exceeds 450 feet (135m) two or more flashing beacons should be installed on each level and installed in a manner to allow unobstructed viewing of at least one beacon.
- h. Prominent Buildings and Similar Extensive Obstructions. If individual objects within a group of obstructions are approximately the same overall height above ground, or water if so situated, and are located not more than 150 feet (45m) apart, the group of obstructions may be considered an extensive obstruction. Prominent buildings and similar extensive obstructions should display steady burning obstruction lights in a manner to indicate the extent of the obstruction as follows:
- (1) Structures Not More Than 150 Feet (45m) in Either Horizontal Direction. If the structure/extensive obstruction is not more than 150 feet (45m) in either horizontal dimension, at least one steady burning obstruction light should be displayed on the highest point of each end of the major axis of the obstruction. If this method of lighting is impracticable because of the shape of the obstruction, then two lights may be displayed in the center of the highest point.
 - (2) Structures More Than 150 Feet (45m) in at Least One Horizontal Direction. If the structure/extensive obstruction is more than 150 feet (45m) in either or both horizontal dimensions, at least one steady burning obstruction light should be displayed for each 150 feet (45m), or fraction thereof, of the overall length of the major axis of the obstruction. At least one of these lights should be displayed on the highest point of each end of the obstruction. Additional lights, as required, should be displayed at approximately equal intervals not to exceed 150 feet (45m) on the highest points or edge between the end lights. If there are two or more edges of the same height on an obstruction located near a landing area, the edge nearest the landing area should be lighted.
 - (3) Special Warning. Flashing or rotating beacons may be used in lieu of steady burning obstruction lights in the event early or special warning is considered necessary. Such beacons should be

displayed on the highest points of an extensive obstruction at intervals not exceeding 3,000 feet (900m). At least three beacons should be displayed on one side of the extensive obstruction to indicate a line of lights.

- (4) Group of Obstructions. If individual objects within a group of obstructions are not the same height and are spaced more than 150 feet (45m) apart, the prominent objects within the group should be lighted in accordance with the specifications for individual obstructions of a corresponding height. In addition, at least one rotating beacon should be installed at the top of a prominent center obstruction or on a special tower located near the center of the group of obstructions.
- (5) Obstructions More Than 150 Feet (45m) AGL. Steady burning obstruction lights should be installed at the top as specified in paragraphs (1) or (2) above. At selected intermediate levels, steady burning lights should be displayed for each 150 feet (45m), or fraction thereof. The position of these lights on the vertical plane should be equidistant between the top lights and the ground level as the shape and type of obstruction will permit. One such light should be displayed at each outside corner on each level with the remaining lights evenly spaced between the corner lights.
- i. Alternate Method of Displaying Obstruction Lights. In lieu of installing lights on the obstruction, lights may be placed on poles of slightly greater height than the obstruction and installed on or adjacent to the structure.

CHAPTER 6. HIGH INTENSITY OBSTRUCTION LIGHTING STANDARDS

17. STANDARDS FOR LIGHTING OBSTRUCTIONS TO AIR NAVIGATION WITH HIGH INTENSITY WHITE OBSTRUCTION LIGHTS. The general standards which follow apply to the obstruction lighting of structures with capacitor discharge obstruction lighting systems. The overall height of a structure including all appurtenances such as rods, antennas, obstruction lighting, etc., are used to determine whether the object is an obstruction to air navigation in accordance with FAR, Part 77, Objects Affecting the Navigable Airspace. However, the overall height of the main structure excluding all appurtenances, is used to determine the number of light levels recommended on a structure. In addition, a white omnidirectional beacon should be displayed on the highest portion of any antenna or other appurtenance, exceeding 20 feet (6m), supported by the main structure. These standards do not require modification of the marking and lighting on existing structures; however, the FAA may recommend that marking and lighting displayed on an existing structure be modified if that structure is altered or replaced by a similar structure.
- a. High Intensity Obstruction Light. The lighting systems referred to in the following standards should conform with the applicable provisions of the latest issuance of FAA Advisory Circular 150/5345-43, FAA/DOD Specification L-856, High Intensity Obstruction Lighting Systems.
 - b. Light Specifications. The following are the basic recommended standards for high intensity obstruction lighting systems applied to structures. However, the intensity, flash rate, sequence and placement of light units are unique in the case of supporting structures of overhead transmission lines. (See paragraph 17.j.)
 - (1) Effective Intensity. Day Mode - no less than 200,000 candelas (100,000 candelas for transmission line supporting structures); twilight mode - approximately 20,000 candelas; night mode - approximately 4,000 candelas.
 - (2) Intensity Step Changing. The systems should automatically change intensity steps when the north sky illumination on a vertical surface is as follows:
 - (a) Day to Twilight. This should not occur before the illumination drops to 60 footcandles but should occur before it drops below 30 footcandles.
 - (b) Twilight to Night. This should not occur before the illumination drops to five footcandles but should occur before it drops below two footcandles.

- (c) Night to Day. The intensity changes listed in (a) and (b) above should be reversed in transitioning from the night to day mode.
- (3) Flash Rate. All light units should flash simultaneously at 40 pulses per minute. (See paragraph 17.j. for flash rate and unique sequencing of catenary systems.)
- (4) Beam Spread. A relatively narrow vertical beam spread is specified to provide full light intensity at possible collision altitudes with the structure while persons on the ground or at altitudes above the structure will receive only stray light.
- (5) Antenna or Similar Appurtenance Light. The specifications for the high intensity lighting system provide for a small omnidirectional white light, similar in size to the 300 mm red flashing beacon, for installation on top of antennas or similar appurtenances. This light should operate 24 hours a day, flash in synchronism with the high intensity lighting system, be of approximately the same intensity as the twilight mode during daylight and reduce in intensity to the night mode simultaneously with the remainder of the system. This appurtenance light should only be used as an adjunct to the high intensity lighting system.
- c. Flashtube Replacements. The flashtubes in a light unit should be replaced when the peak effective daytime intensity falls below 200,000 candelas (100,000 candelas for systems installed on the supporting structures of overhead transmission lines).
- d. Installation Guidance. The manufacturing specifications provide for the peak intensity of the light beam to be capable of angular adjustment from zero to eight degrees above the horizontal. The normal installation would be for all light units to be installed at zero degrees elevation. Where terrain, nearby residential areas or other situations dictate, it may be desirable to use louvers and/or elevate the light beam above the horizontal. The beam of the light at the lower level should not strike the ground closer than three statute miles (5km) from the structure to prevent irritation to nearby residents. Should elevating the light beam be necessary, it is recommended that the beam be elevated (in degrees above the horizontal) as shown below. If additional adjustments are necessary, each light may be adjusted upward, in one degree increments, starting at the bottom. The top light should normally remain at zero degrees to the horizontal.

Level of Light	<u>Number of Levels of Lights Installed</u>					
	<u>1</u>	<u>2</u>	<u>3</u>	<u>4</u>	<u>5</u>	<u>6</u>
Top	0	0	0	0	0	0
5	-	-	1	1	0	0
4	-	-	-	2	1	1
3	-	-	-	-	2	2
2	-	-	-	-	-	2
Bottom	-	2	2	3	3	3

Figures indicate degrees of elevation above the horizontal.

- e. High Intensity Light Units. The high intensity capacitor discharge light units known to date which meet the FAA/DOD specification L-856 are not omnidirectional, except for the light used on antennas or similar appurtenances. See paragraph 17.b.(5). Therefore, more than one light unit is required in order to obtain 200,000 candelas for 360 degrees of coverage about a structure to ensure that the system is visible from aircraft at any normal angle of approach. A light unit may contain one or more flashtubes.
- (1) Number of Levels of Lights. The number of levels of lights used is dependent upon the overall height of the structure above ground level. The lights should be installed at the levels indicated in Appendix 2, Figs. 4-6, for chimneys and similar solid structures. On structures having an antenna or similar appurtenance extending more than 20 feet (6m) above the main structure, such as a radio or television antenna, the lights should be installed at the levels indicated in Appendix 2, Figs. 7-9. The light levels recommended for other structures, i.e., cooling towers, supporting structures of catenaries and buildings, may be found under the appropriate subject paragraph.
- (2) Number of Light Units Per Level. The number of light units recommended per level (except for the supporting structures of transmission lines and buildings) is dependent upon the average outside diameter of the specific structure:
- (a) Structures 20 feet (6m) or less - three light units per level.

- (b) Structures exceeding 20 feet (6m) but not more than 100 feet (30m) - four light units per level.
 - (c) Structures exceeding 100 feet (30m) but not more than 200 feet (60m) - six light units per level.
 - (d) Structures exceeding 200 feet (60m) - eight light units per level.
- f. Relocation or Omission of Light Units. Light units should not be installed in such a manner or elevation on a structure that the intended purpose would be derogated.
- (1) Lowest Level. The lowest level of light units may be installed at a higher elevation than normal for the height of the structure if the lights, by installing them at the prescribed elevation, would be lower than surrounding terrain, trees or adjacent building(s). See Appendix 1, Fig. 7. In certain instances, as determined by an FAA aeronautical study, the elimination of the lowest level may be permissible.
 - (2) Two Adjacent Structures. Where two structures are situated within 200 feet (60m) of each other and the light units will be installed at the same levels, the sides of the structures facing each other need not be lighted; therefore, the inboard lights may be eliminated; however, all lights on both structures must flash in synchronism. Minor adjustments in the vertical placement of the lights to either or both of the structure's intermediate levels of lights may be made in order to place the lights on the same horizontal plane. Where one structure is higher than the other, complete level(s) of lights should be installed on that part of the higher structure which extends above the top of the lower structure. If the structures are of such heights that the levels of lights cannot be placed in identical horizontal planes, then the light units should be placed such that the center of the horizontal beam patterns do not face toward the adjacent structure. For example, structures situated north and south of each other should have the light units on both structures installed on a northwest/southeast and northeast/southwest orientation. See Appendix 1, Figs. 6, 7 and 8.
 - (3) Three or More Adjacent Structures. The treatment of a cluster of structures as individual structures or a complex will be determined by the FAA as the result of an aeronautical study, taking into consideration the structure's location, heights and spacing between structures.

- g. Chimneys, Flare Stacks and Similar Solid Structures. The number of levels of lights recommended depends on the height of the structure and may be obtained from Appendix 2, Figs. 4-6. The amount of light units recommended for each level is dependent on the outside diameter of the structure but should in no case be less than three. The light units should be installed in a manner to ensure unobstructed viewing of the system from aircraft at any normal angle of approach. Normally, the top level of light units are installed on the highest point of a structure. However, in the case of chimneys, the top level of lights may be installed from five (1.5m) to 10 feet (3m) below the top. This is to avoid the obscurant effects of the deposits generally emitted by this type structure.
- h. Radio and Television Towers and Similar Skeletal Structures.
- (1) Mounting of Lights. The number of levels recommended depends on the height of the structure, excluding antennas and similar appurtenances, and may be obtained from Appendix 2, Figs. 7-9. At least three lights should be installed on each level and mounted so that the effective intensity over the full beam is not impaired by the structural members. They should be mounted in a manner to ensure unobstructed viewing from aircraft at any normal angle of approach.
 - (2) Ice Shields. Where climatic conditions dictate, metal grates or similar protective ice shields should be installed directly over each light unit to prevent falling ice accumulation from damaging the light units.
 - (3) Top Level of Lights. One level of lights should be installed at the highest point of the structure. If the highest point is a rod or antenna incapable of supporting a lighting system, then the top level of lights should be installed at the highest portion of the main skeletal structure. If the rod or antenna is more than 20 feet (6m) above the main structure, a white capacitor discharge omnidirectional light should be mounted on the highest point. If the appurtenance (such as a whip antenna) is incapable of supporting the omnidirectional light, one such light should be installed on a pole of slightly greater height than the obstruction and mounted immediately adjacent to the appurtenance.
 - (4) Intermediate Levels of Lights. The intermediate levels of lights should be installed at approximately the same heights shown in Appendix 2, Figs. 7-9.
- i. Hyperbolic Cooling Towers.
- (1) Mounting of Obstruction Lights. The light units should be installed in a manner to ensure unobstructed visibility of at least two lights from aircraft at any normal angle of approach.

12/11/73

More than one light unit should be visible to provide the required intensity about the structure and to indicate to pilots the magnitude of the structure.

- (2) Top Level of Obstruction Lights. The number of light units recommended depends on the diameter of the structure at the top. See paragraph 17.e.(2).
 - (3) Structures Exceeding 600 feet (180m) AGL. Structures greater than 600 feet (180m) AGL should have one additional level of light units installed approximately mid-point on the structure and in line with the top level of lights.
- j. Supporting Structures of Overhead Transmission (Catenary) Lines.
- (1) Purpose. The purpose of marking the supporting structures of overhead transmission lines with a unique, sequentially flashing lighting system is to warn pilots of the presence of the support structures themselves and to alert pilots that they support a catenary line.
 - (2) Mounting of Obstruction Lights. A system of three levels of sequentially flashing light units should be installed on each supporting structure (or adjacent terrain) of an overhead transmission line. One level should be installed at the top of the structure; one at the height of the lowest point in the catenary; and one level at approximately midway between the other two lights. The middle level should normally be a minimum of 50 feet (15m) from the other two levels. If the installation of the top level of lights presents a potential danger to maintenance personnel, or is necessary for lightning protection, such lights may be mounted from five (1.5m) to 10 feet (3m) below the highest point of the structure.
 - (a) Flash Sequence. The flash sequence should be middle level, top level and bottom level with all lights on the same level flashing simultaneously. The time delay between flashes of the levels is designed to present a unique system display similar to a flash of lightning.
 - (b) Flash Rate. Each series of flashes is repeated 60 times every minute.
 - (c) Horizontal Coverage. Two or more light units should be installed at each light level and directed on a horizontal plane such as to provide 180 degrees of coverage centered on the transmission line. Where a catenary crossing is situated near a bend in a river, canyon, etc., the direction

of the horizontal beam pattern should be directed to provide the most effective light coverage to warn pilots approaching from either direction of the presence of the transmission lines.

- (d) Variation. The vertical and horizontal arrangements of the lights may be subject to the structural limits of the towers and/or adjacent terrain and a tolerance of 20 percent from uniform spacing of the bottom and middle light is allowed. If the base of the supporting structure(s) is higher than the lowest point in the catenary, such as a canyon crossing, one or more lights should be installed on the adjacent terrain at the level of the lowest point in the span.
- (3) Special Cases. Where lighting systems are installed on supporting structures located near vehicular bridges, waterways, airport approach areas, etc., caution should be exercised to ensure that the lights do not cause a hazard to motorists, vessel operators or pilots on an approach to an airport. In these cases, shielding or an adjustment to the vertical or horizontal light direction may be necessary. This adjustment should not derogate the intended purpose of the lighting system.
- (4) Area Surrounding Support Structures. The area in the immediate vicinity of the base of the supporting structures should be cleared of all structures and objects of natural growth that could interfere with the line-of-sight between a pilot and the obstruction lights.
- (5) Omission of Standard Marking. When the high intensity obstruction lighting system is used to identify a catenary line crossing, the following marking and lighting may be omitted:
 - (a) Spherical markers on the lines.
 - (b) The marking of the supporting structures for the surface area having the same exposure covered by this lighting system.
 - (c) The installation of red obstruction lights on the supporting structures serving the same exposure covered by the high intensity obstruction lighting system.
- (6) Total Elimination of Marking and Red Obstruction Lights. Transmission line supporting structures having a catenary extending in one direction only and obstruction lighted as outlined under paragraph 17.j.(2) may omit the standard marking and red obstruction lighting provided:

12/11/73

- (a) At least three light units are installed on the top level and situated so as to provide 360 degrees coverage about the structure. Four lights should be used if any light is installed more than 20 feet (6m) from another light on the top level. In addition, four light units may be required to effectively cover the approach to the structure dependent upon the beam pattern of the light unit and possible directions of approach. In certain situations, it may be desirable to have three lights on the top level of one supporting structure and four on the companion structure to provide adequate obstruction lighting coverage.
 - (b) Structures exceeding 500 feet (150m) above ground, or water if so situated, have at least three light units installed at the middle level to provide 360 degrees coverage.
 - (c) All lights at each level flash simultaneously.
- (7) Three or More Supporting Structures. Where a transmission line crossing requires three or more supporting structures, the inner structures should be equipped with three or four light units per level to provide 360 degrees coverage. The number will depend upon the beam pattern of the particular manufacturer's light and the area desired to be covered as determined by the possible directions of approach. Four lights should be used if any light is installed more than 20 feet (6m) from another light on any level. Structures equipped with a lighting system providing 360 degrees of coverage about the structure may delete the standard marking and red obstruction lighting system.
- k. Prominent Buildings, Observation Towers and Similar Extensive Obstructions. Prominent obstructions should have lights installed at the highest portion or edge of the obstruction, on the same horizontal plane and provide 360 degrees of coverage about the obstruction. They should be installed in a manner to indicate the extent of the obstruction and to ensure unobstructed visibility of at least two light units from aircraft at any normal angle of approach.
- (1) If the obstruction is not more than 200 feet (60m) in either horizontal dimension, there should be installed at the highest portion of the structure three or more light units in a manner to ensure that at least one light is visible from aircraft at any normal angle of approach. They may be mounted on a single pedestal at or near the center of the obstruction. If the light units are placed more than 20 feet (6m) from a central point, a minimum of four light units should be used.

- (2) If the obstruction is more than 200 feet (60m) in one horizontal dimension, but not more than 200 feet (60m) in the other, two light units should be placed on each of the shorter sides. These light units may either be installed adjacent to each other at the mid-point of the edge of the obstruction or at or near each corner and directed horizontally such as to give 180 degrees of coverage to each end of the obstruction. One or more light units should be installed along the overall length of the major axis. These lights should be installed at approximately equal intervals not to exceed a distance of 100 feet (30m) from the corners of each other.
- (3) If the obstruction is more than 200 feet (60m) in both horizontal dimensions, there should be installed one light unit for each 100 feet (30m) or fraction thereof of the overall perimeter of the obstruction.

CHAPTER 7. DUAL LIGHTING SYSTEMS

18. DUAL LIGHTING SYSTEMS. Red (nighttime) and high intensity white (daytime) obstruction lighting systems may be utilized under certain conditions when it might not be feasible to operate the high intensity white lighting systems at night. The use of the high intensity white lights for daytime obstruction lighting precludes the painting recommendations. The systems should be installed and operated as specified in Chapters 4, 5 and 6. The light units should be installed as though each system was the only system being used. However, the levels of lights recommended for the high intensity lighting systems may be adjusted, if necessary, to coincide with the nearest platform used for the red obstruction lights. The lights should be installed as specified in Appendix 2, Figs. 10-12.

CHAPTER 8. MARKING AND LIGHTING OF MOORED BALLOONS AND KITES

19. PURPOSE. To describe marking and lighting standards for moored balloons and kites for the purpose of indicating to airmen the general definition of these objects and to warn pilots of their presence when converging from any normal angle of approach.
20. APPLICATION. This chapter pertains to all moored balloons and kites which require marking and lighting under Part 101 of the Federal Aviation Regulations.
21. MARKING. Pennant, streamers or similar type markers should be used on mooring lines to warn airmen of their presence during daylight hours.
 - a. Display. Markers should be displayed at not more than 50-foot (15m) intervals beginning at 150 feet (45m) above the surface of the earth and should be visible for at least one mile.
 - b. Shape. Markers should be rectangular in shape and not less than two feet on a side. Stiffeners should be used in the borders to prevent drooping in calm wind, wrapping around the cable, and to expose a large area in light air.
 - c. Color Patterns. One of the following color patterns should be used:
 - (1) Solid color aviation orange.
 - (2) Two triangular sections, one of aviation orange and the other of white, combined to form a rectangle.
22. LIGHTING. High intensity white flashing lights should be used on moored balloons or kites and their mooring lines to warn airmen of their presence during the hours between sunset and sunrise or, they may remain on continuously. Xenon type lights are acceptable. (It is not intended that lights meeting the L-856 specifications be used.)
 - a. Display. Flashing lights should be displayed on the top, nose section, tail section and on the tether cable approximately 15 feet (4.5m) below the craft so as to define the extremes of size and shape. Additional lights should be equally spaced along the cable's overall length for each 350 feet (105m) or fraction thereof.
 - b. Light Distribution. The intensity of each light should be approximately 1,000, and preferably 1,500, effective candelas at every point in the horizontal plane (and a minimum of two degrees in the vertical plane) with a flash rate of 40 pulses per minute.

12/11/73

23. LIGHT CONTROL DEVICE. The operation of each light may be controlled by a photocell controller which automatically turns the light on when the north illumination on a vertical surface drops to 60 footcandles but before reaching 30 footcandles. The reverse order should apply in transitioning from nighttime to daytime operation.
24. OTHER FEDERAL OR LOCAL GOVERNMENT REGULATIONS. Rules and regulations as prescribed by the FAA and other Federal and local government agencies pertaining to the use of balloons, kites and associated equipment in the navigable airspace are not affected and shall apply.

CHAPTER 9. OBSTRUCTION MARKING AND LIGHTING EQUIPMENT

25. PURPOSE. This chapter lists all of the documents relating to the obstruction painting and lighting of objects and advises where they may be obtained.
26. PAINT. Paint and aviation colors referred to in the standards set forth in this publication should conform to Federal Standards FED-STD-595, Colors, as follows:
- a. Colors.
- (1) Orange Number 12197 (Aviation Surface Orange).
 - (2) White Number 17875 (Aviation White).
- b. Availability of Specifications. FED-STD-595 and other Federal specifications describing the technical characteristics of various paints and their application techniques may be obtained from:
- Specification Activity
Building 197, Room 301
Naval Weapons Plant
First and N Streets, S. E.
Washington, D. C. 20407
27. LIGHTS AND ASSOCIATED EQUIPMENT. The lighting equipment referred to in the standards set forth in this publication should conform with the applicable provisions of the following specifications and their related drawings.
- a. Aviation Red Obstruction Lighting System.
- (1) Color. Military Specification MIL-C-25050 Colors; Aeronautical Lights and Lighting Equipment.
 - (2) Flashing Beacons. FAA Specification CAA 446, Code Beacons, 300 mm.
 - (3) Double and Single Obstruction Lights.
 - (a) Military Specification MIL-L-7830, Light, Navigational Boundary and Obstruction Markers.
 - (b) FAA Advisory Circular Number 150/5345-2, Specifications for L-810 Obstruction Light.

12/11/73

- (4) Covers for Aeronautical Lights. Military Specification MIL-C-7989 Covers; Light-Transmitting (for Aeronautical Lights).
- b. High Intensity White Obstruction Lighting Systems. FAA Advisory Circular Number 150/5345-43, FAA/DOD Specification L-856, High Intensity Obstruction Lighting Systems.
- c. Approved Manufacturers. FAA Advisory Circular Number 150/5345-1, Approved Airport Lighting Equipment, lists the approved airport lighting equipment and manufacturers qualified to supply their product in accordance with the indicated specification requirements.
- d. Installation and Maintenance. FAA Advisory Circular Number 150/5340-21, Airport Miscellaneous Lighting Visual Aids, provides guidance for the installation, maintenance and testing and inspection of the red beacon and steady burning obstruction lighting.
- e. Availability. The standards and specifications listed above may be obtained free of charge from the designated facility:

(1) Military Specifications:

Commanding Officer
Naval Publications and Forms Center
5801 Tabor Avenue
Attention: NPFC-105
Philadelphia, Pennsylvania 19120

(2) FAA Specifications:

Chief, Configuration Control Branch, AAF-110
Department of Transportation
Federal Aviation Administration
800 Independence Avenue, S. W.
Washington, D. C. 20591

(3) FAA Advisory Circulars:

Department of Transportation
Distribution Unit, TAD-484.3
Washington, D. C. 20590

f.

RECOMMENDED LAMP EQUIPMENT

Multiple Circuits

<u>Typical Service</u>	<u>Watts</u>	<u>Volts or Amps.</u>	<u>Bulb</u>	<u>Base</u>	<u>Average Rated Lab. Life (Hours)</u>	<u>Approx. Lumens</u>	<u>Specifications</u>	
							<u>FAA</u>	<u>MIL</u>
Double & Single Obstruction	125	120V	A-21	Md. Pf.	6,000	1,220	L-810	
	116	120V	A-21	Md. Scr	6,000	1,260	L-810	L-7830 L-7830
Flashing Beacon	700	120V	PS-40	Mg. Pf.	6,000	11,200	446	L-6273
	620	120V	PS-40	Mg. Pf.	3,000	11,200	446	L-6273
High Intensity White Obstruction Lights		480V 240V 120V					L-856	

Series Circuit

Obstruction Lights		6.6A	A-21	Md. Pf.	2,000	1,020	L-810	L-7830
--------------------	--	------	------	---------	-------	-------	-------	--------

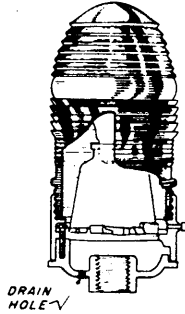

SINGLE OBSTRUCTION
LIGHT FITTING
(Fresnel Globe)

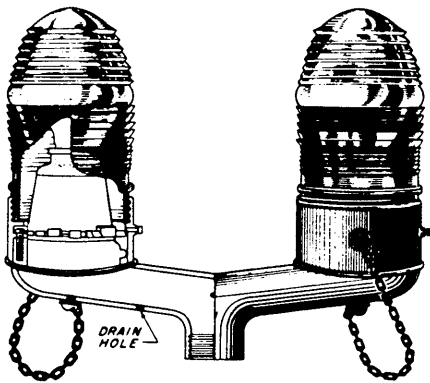

DOUBLE OBSTRUCTION
LIGHT FITTING
(Fresnel Globe)

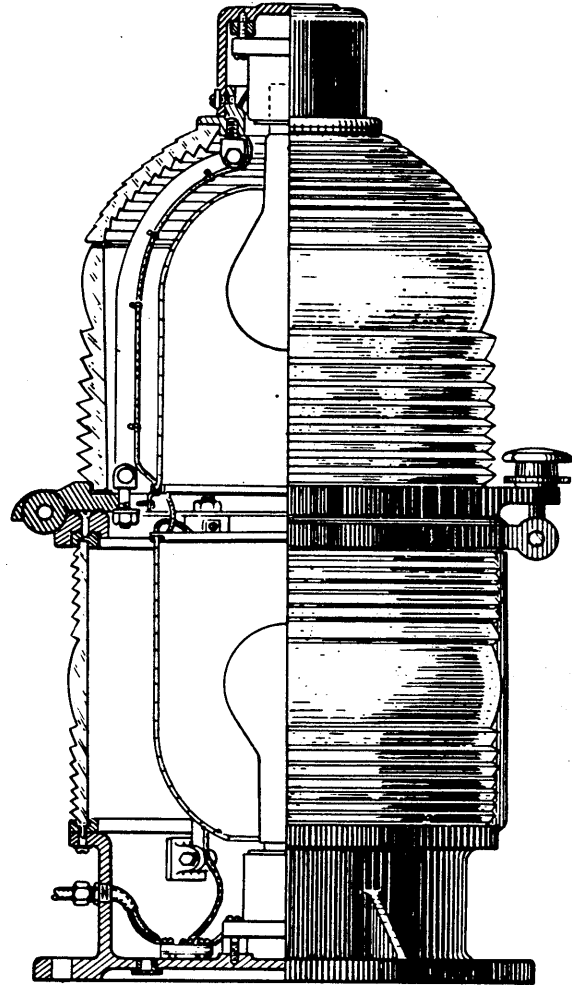

300 mm BEACON
(Fresnel Lens)

TYPES OF OBSTRUCTION LIGHTS

FIG. 1

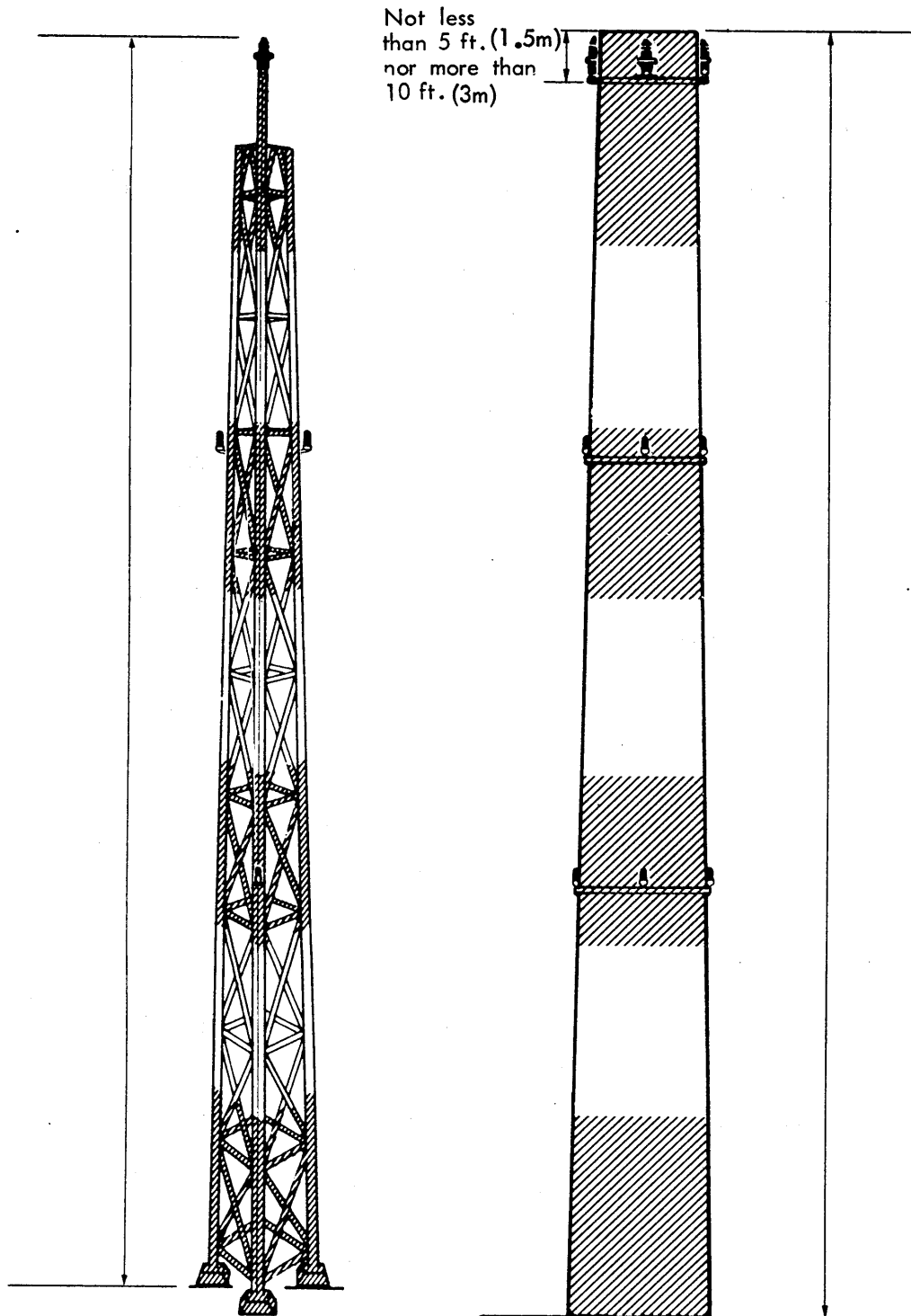

More than 300 ft. (90m) but not more than 450 ft. (135m)

PAINING AND LIGHTING OF CHIMNEYS, POLES, TOWERS
AND SIMILAR OBSTRUCTIONS

Fig. 2.

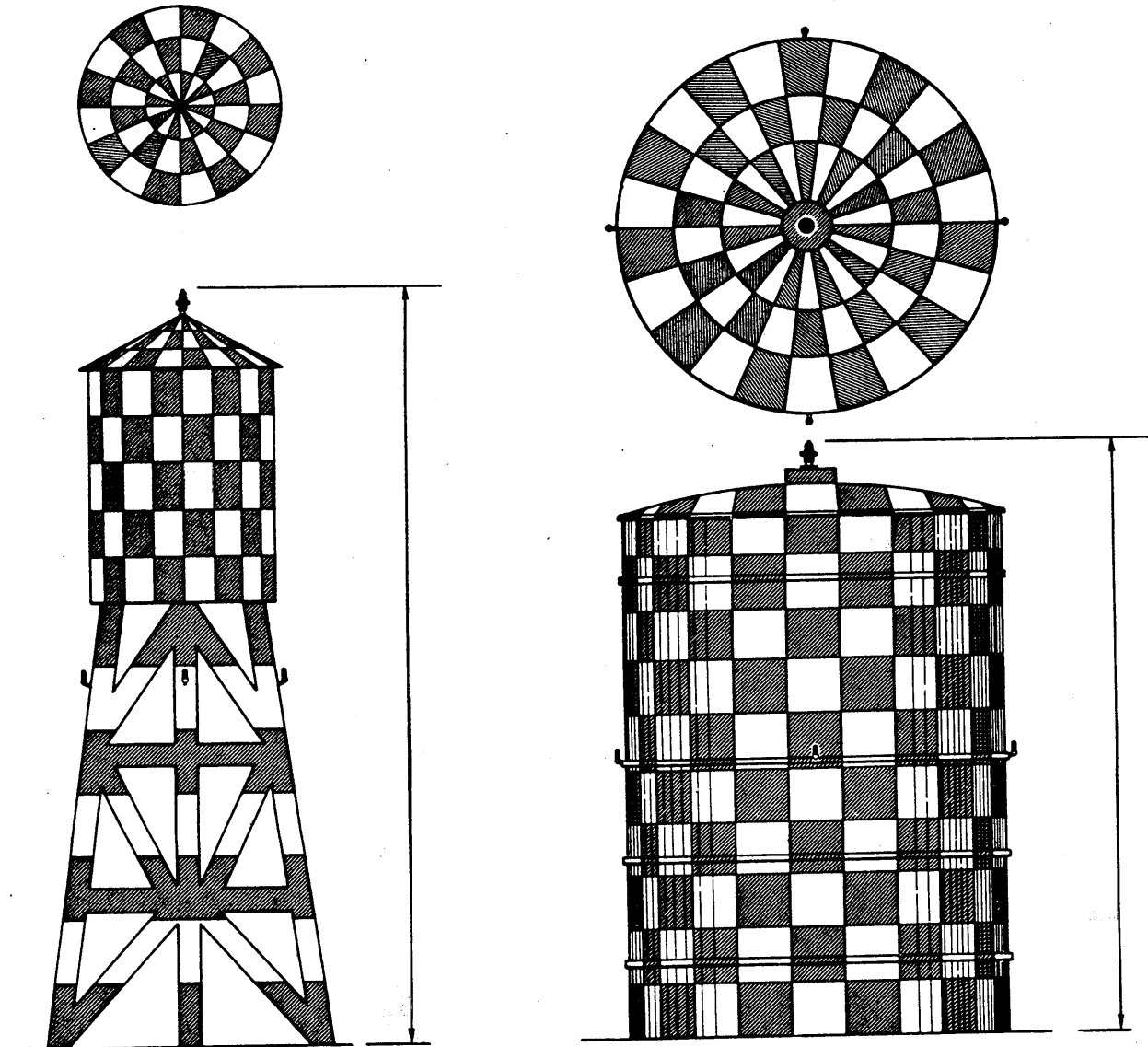

LIGHTING

More than 150 ft. (45m) but
not more than 300 ft. (90m)

LIGHTING

More than 150 ft. (45m) but
not more than 300 ft. (90m)

PAINTING AND LIGHTING OF WATER TOWERS, STORAGE TANKS
AND SIMILAR OBSTRUCTIONS

Fig. 3.

12/11/73

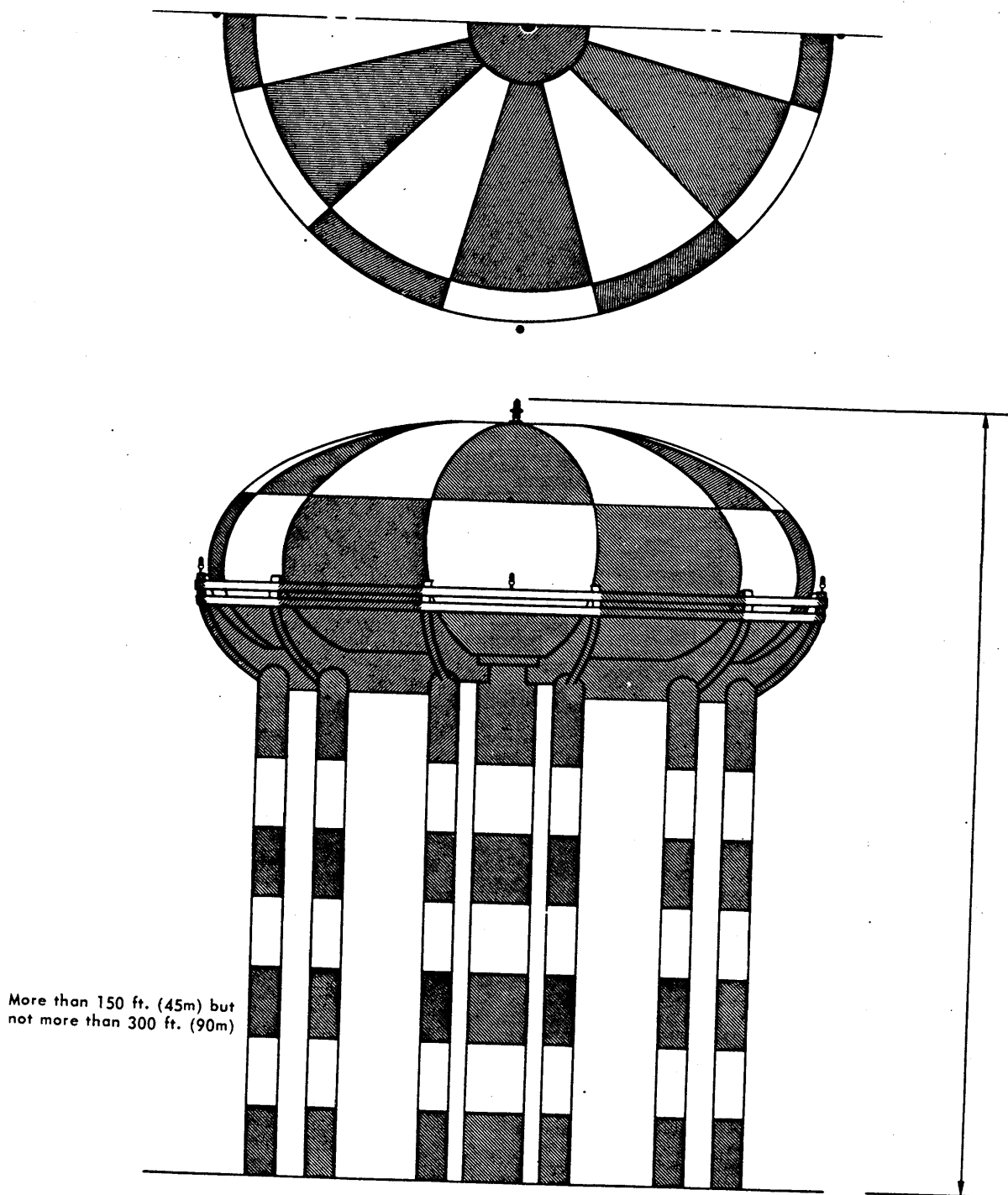

PAINING AND LIGHTING OF WATER TOWERS AND SIMILAR OBSTRUCTIONS

Fig. 4.

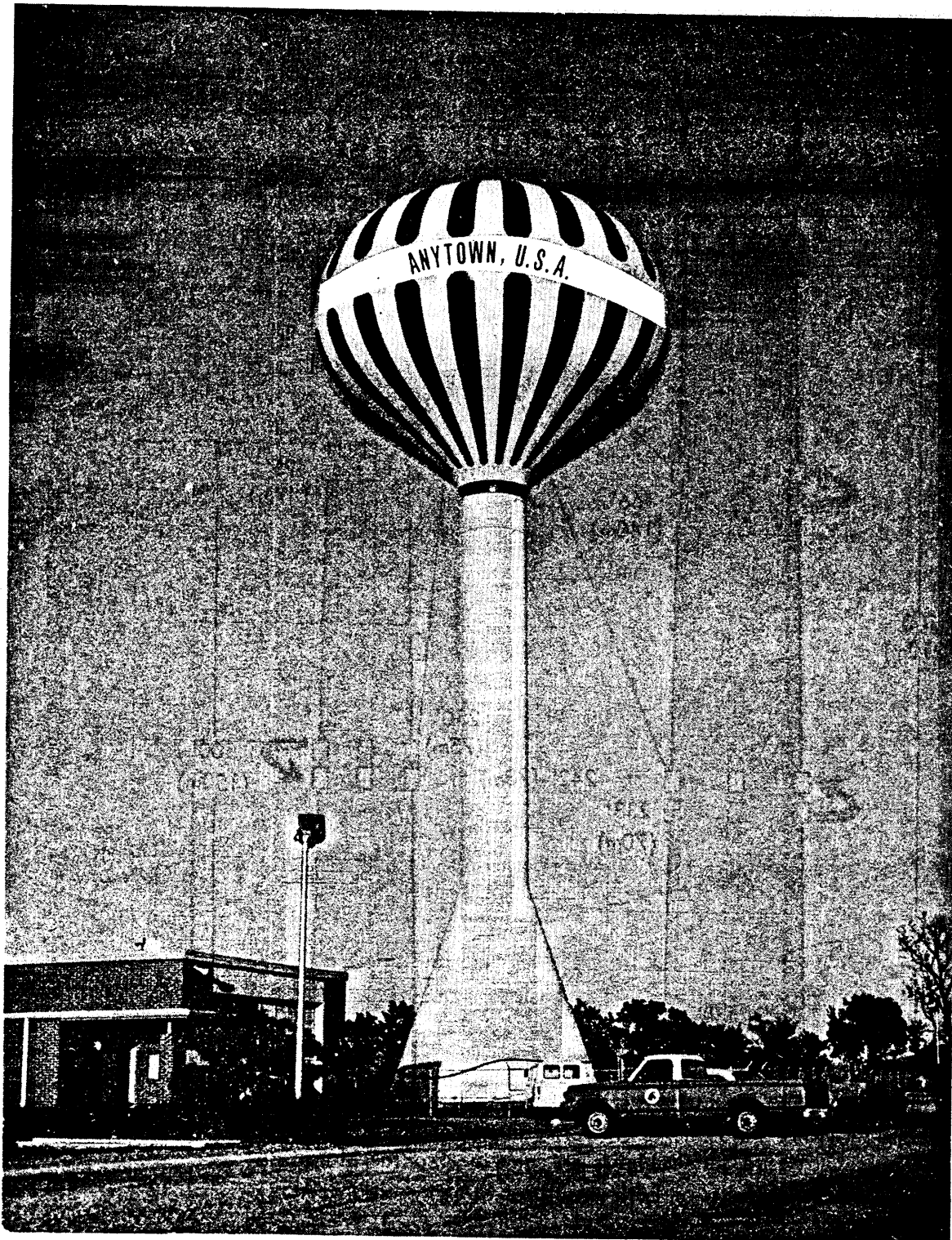

PAINTING OF SINGLE PEDESTAL WATER TOWER BY BEACHBALL PATTERN

Fig. 5.

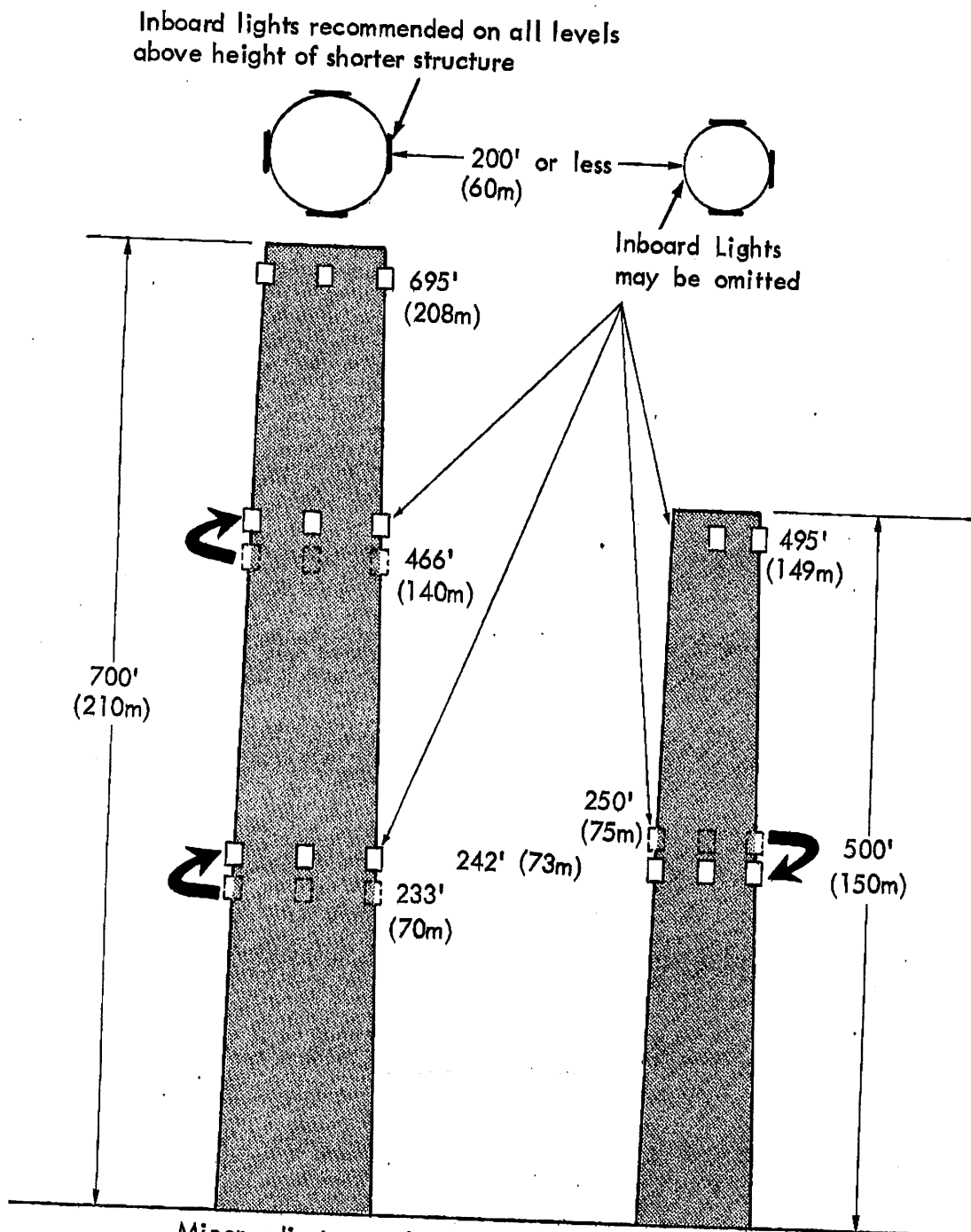

Minor adjustments in vertical placement may be made to place Lights on same horizontal plane. Lights on both structures to be synchronized.

17. f. (2)

Fig. 6.

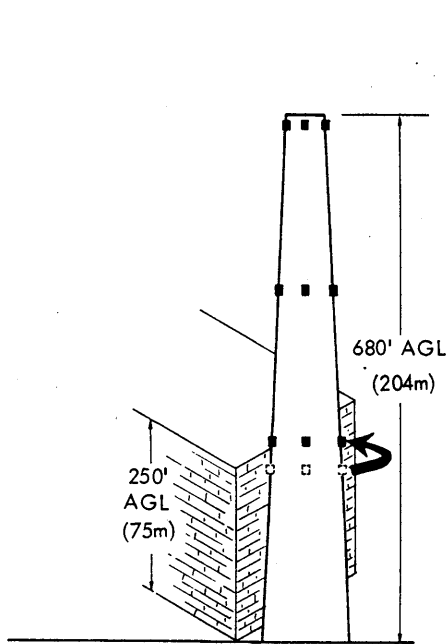

Lowest level should be above adjacent structure.

17. f. (1)

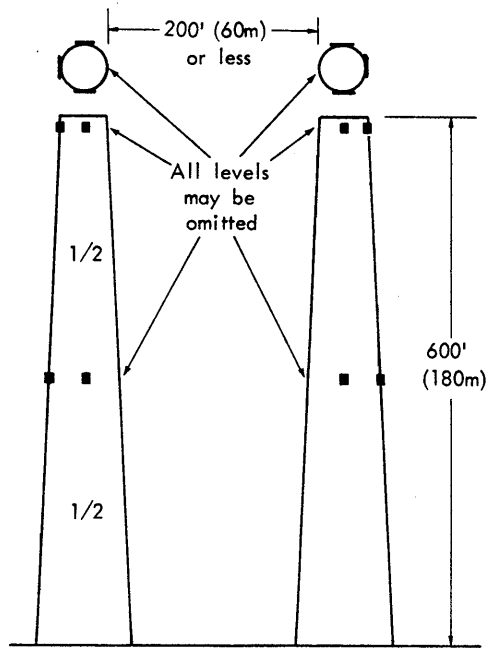

Structures of equal height. Number of levels depend upon height of structure. Lights on both structures to be synchronized.

17. f. (2)

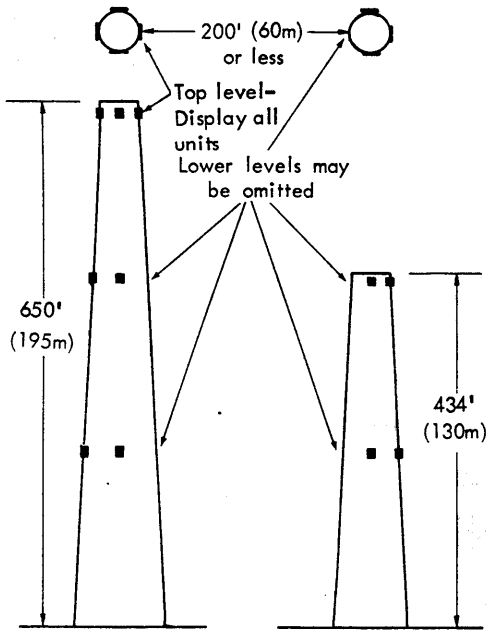

One structure higher than adjacent structure and light levels are on same horizontal plane. Lights on both structures to be synchronized.

17. f. (2)

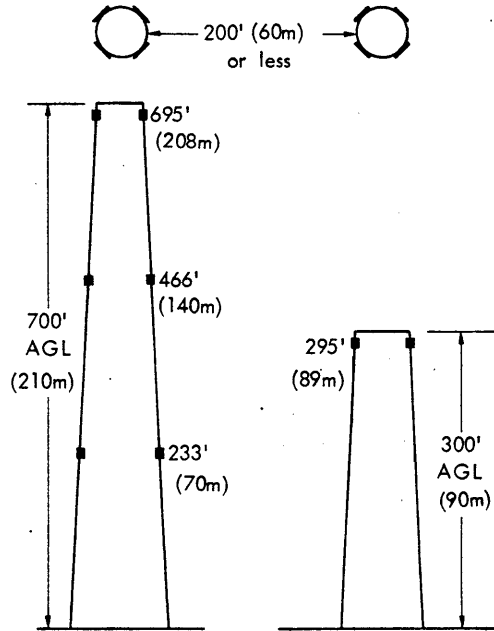

One structure higher than adjacent structure and light levels are not on same horizontal planes.

17. f. (2)

Fig. 7.

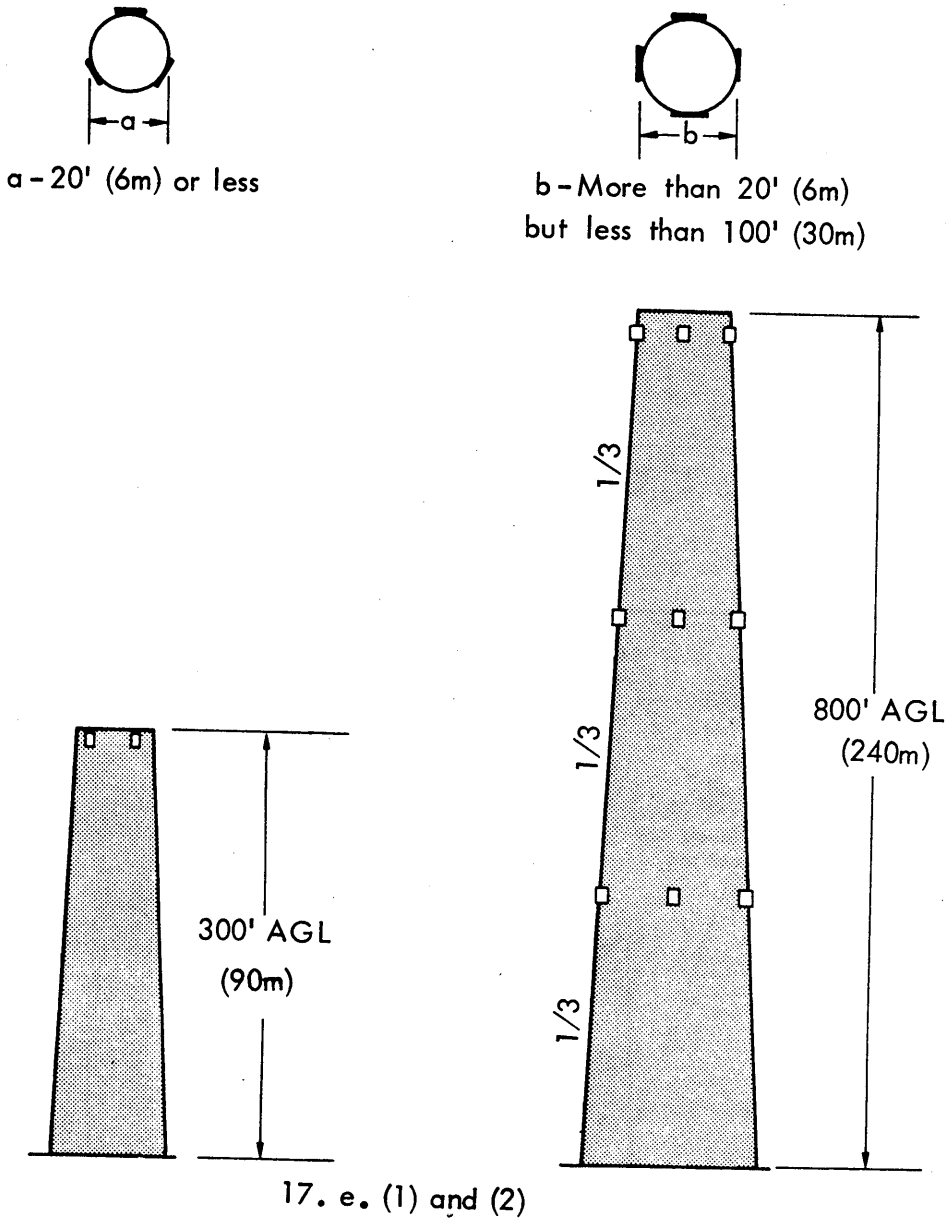

17. e. (1) and (2)

Fig. 8.

12/11/73

AC 70/7460-1C
Appendix 1

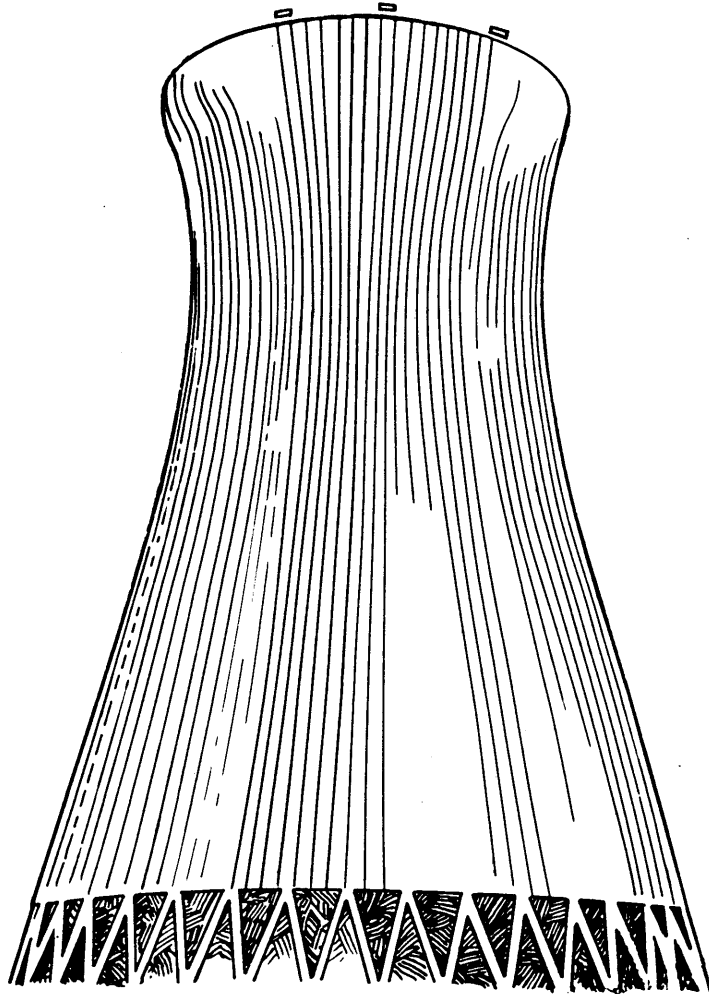

HYPERBOLIC COOLING TOWER

FIG. 9

12/11/73

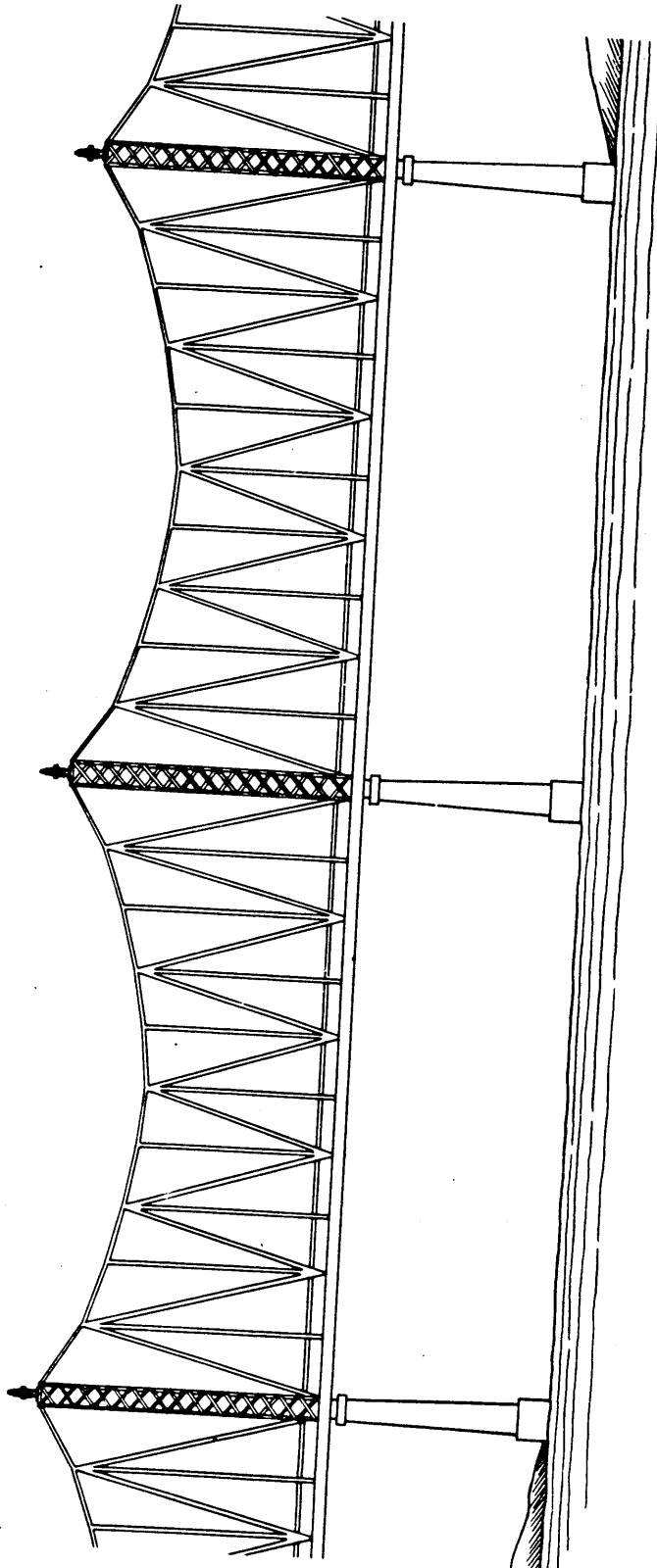

BRIDGE LIGHTING

Fig. 10.

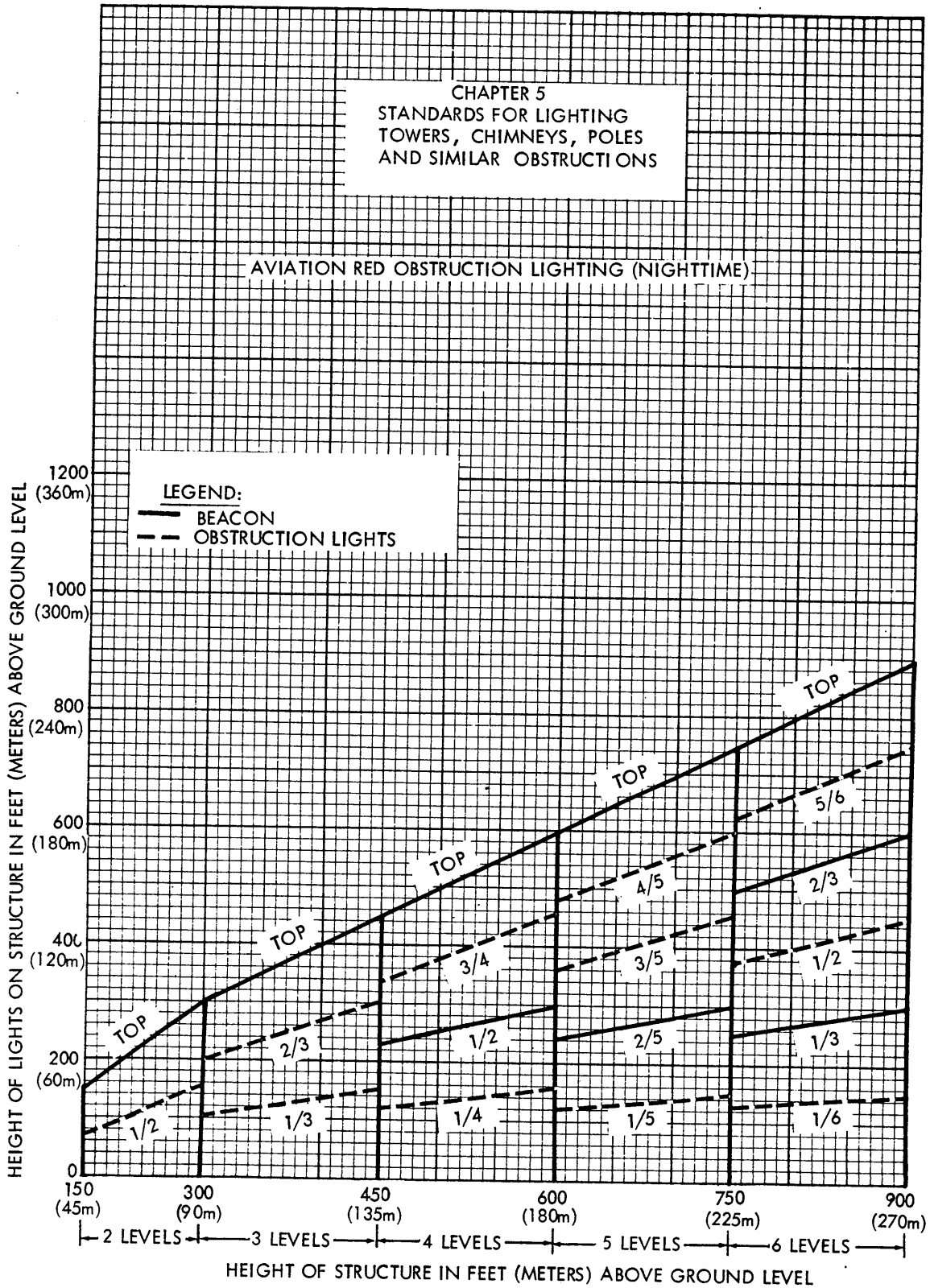

Fig. 1.

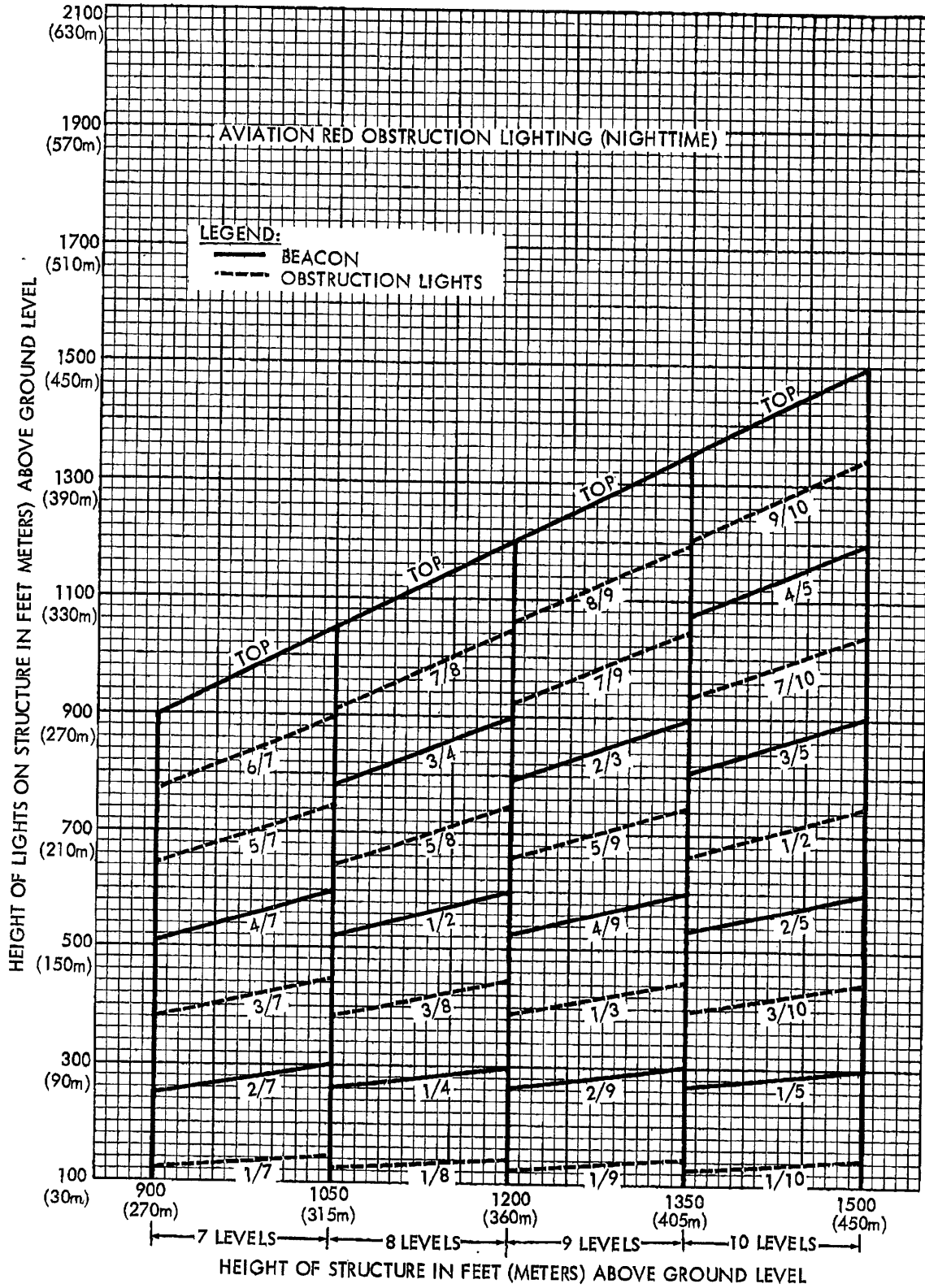

Fig. 2.

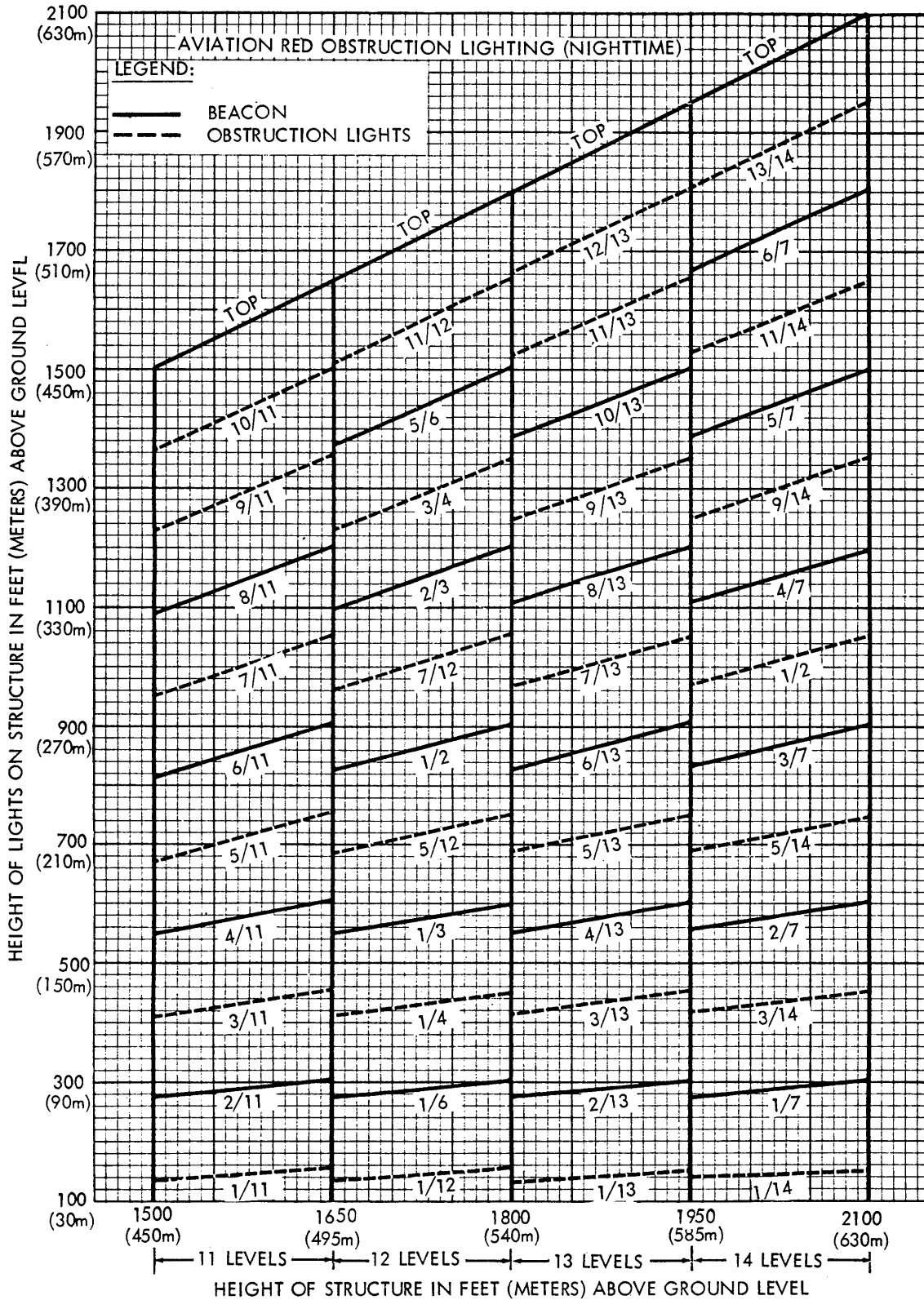

Fig. 3.

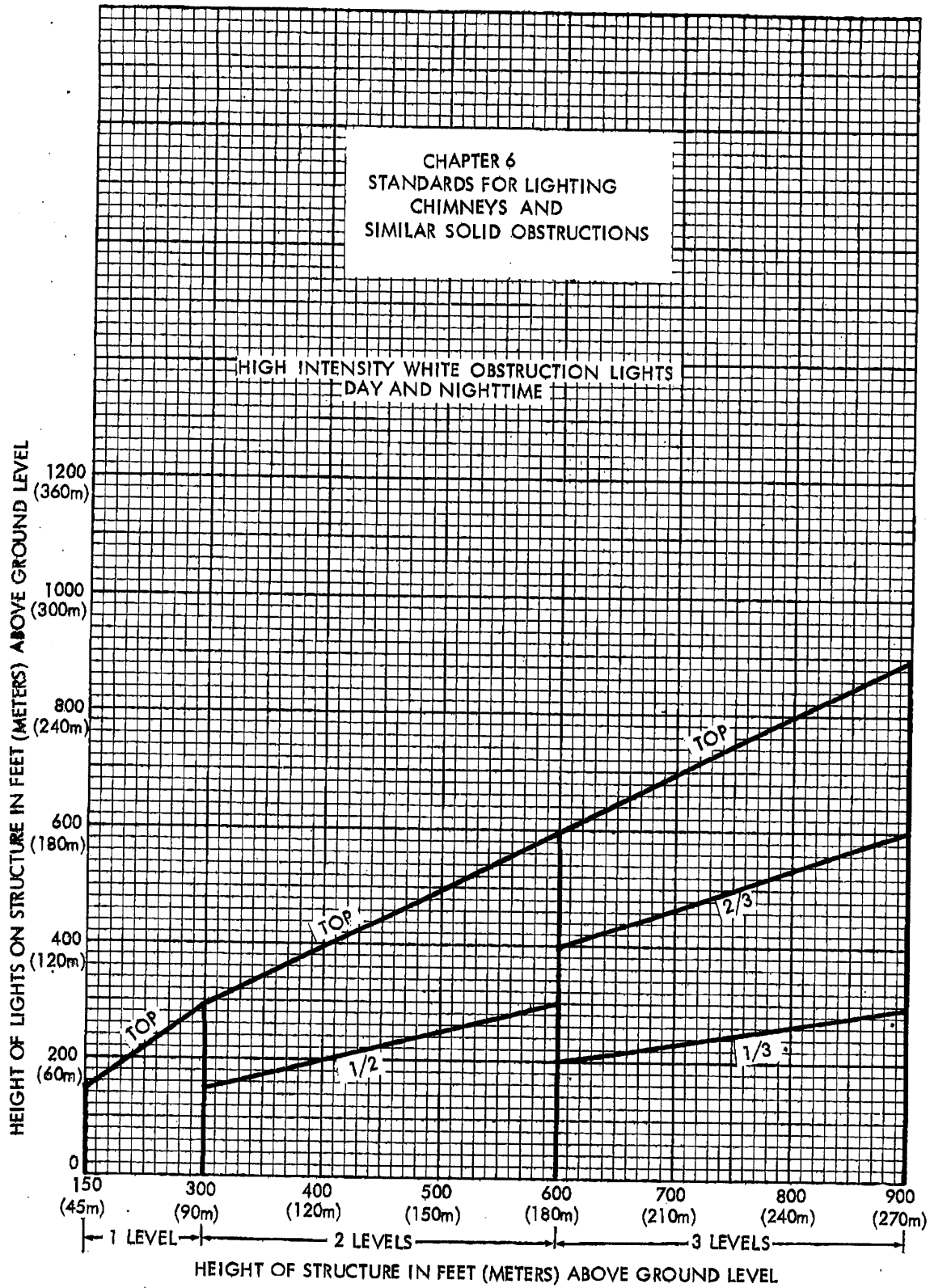

Fig. 4.

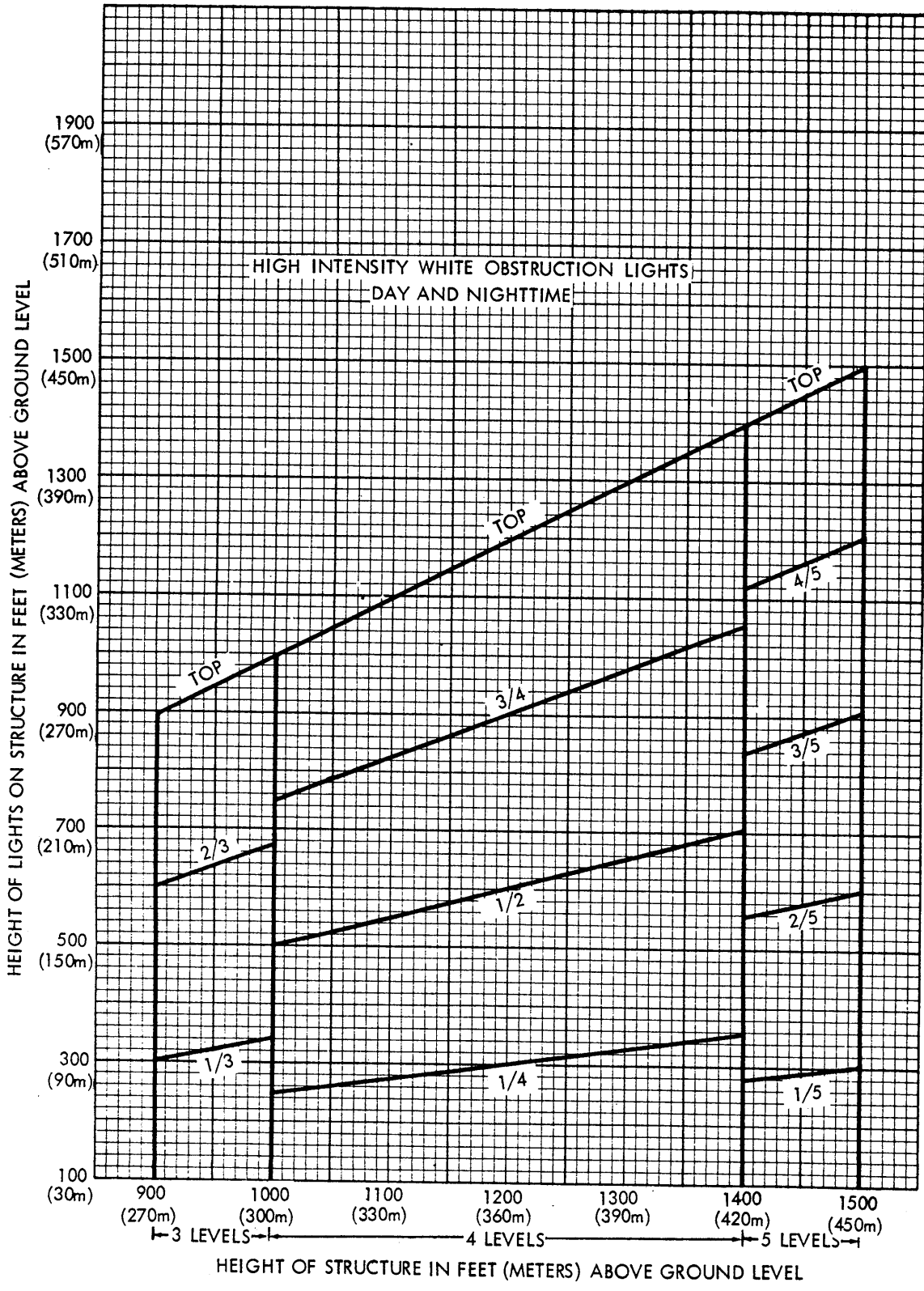

Fig. 5.

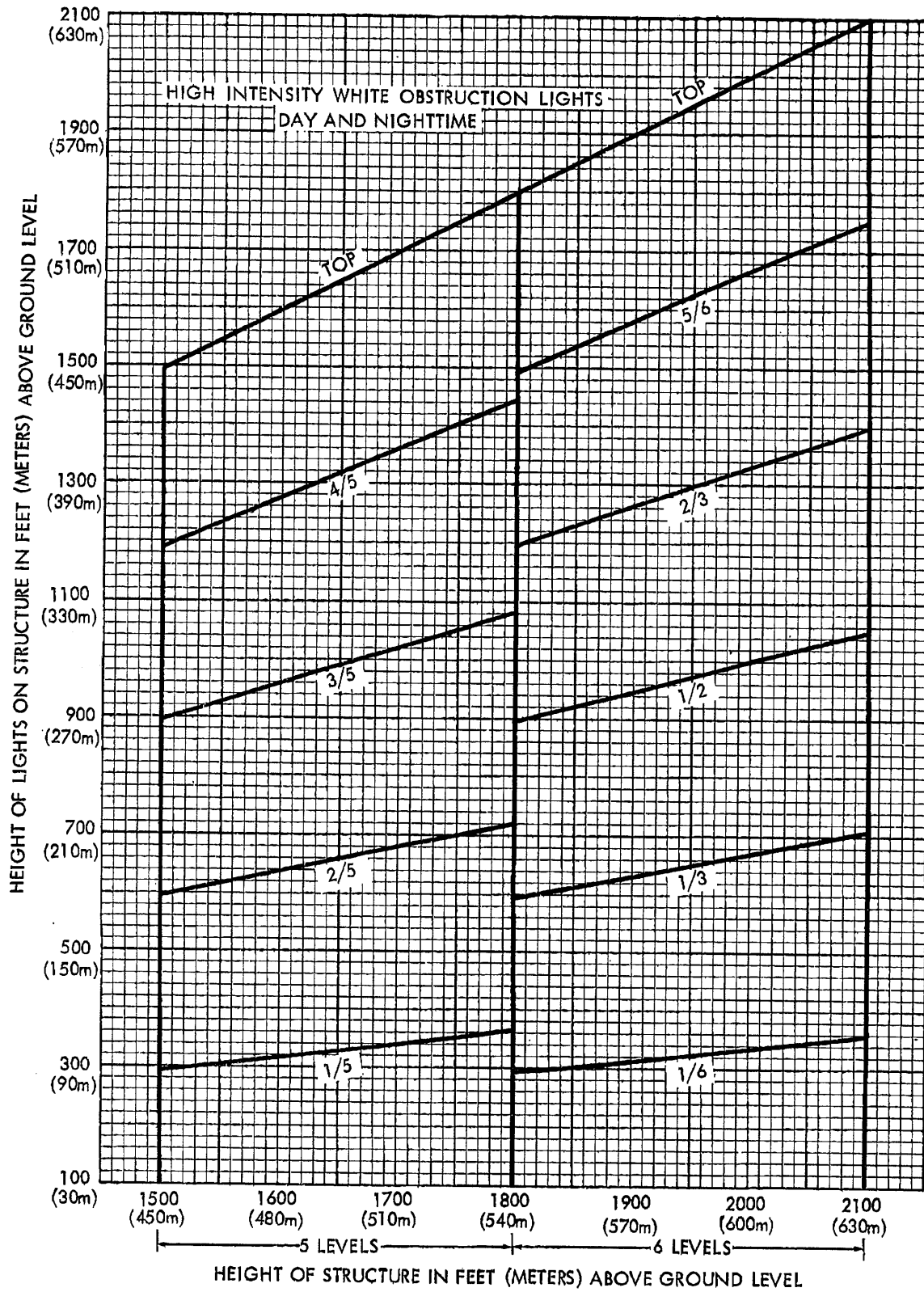

Fig. 6.

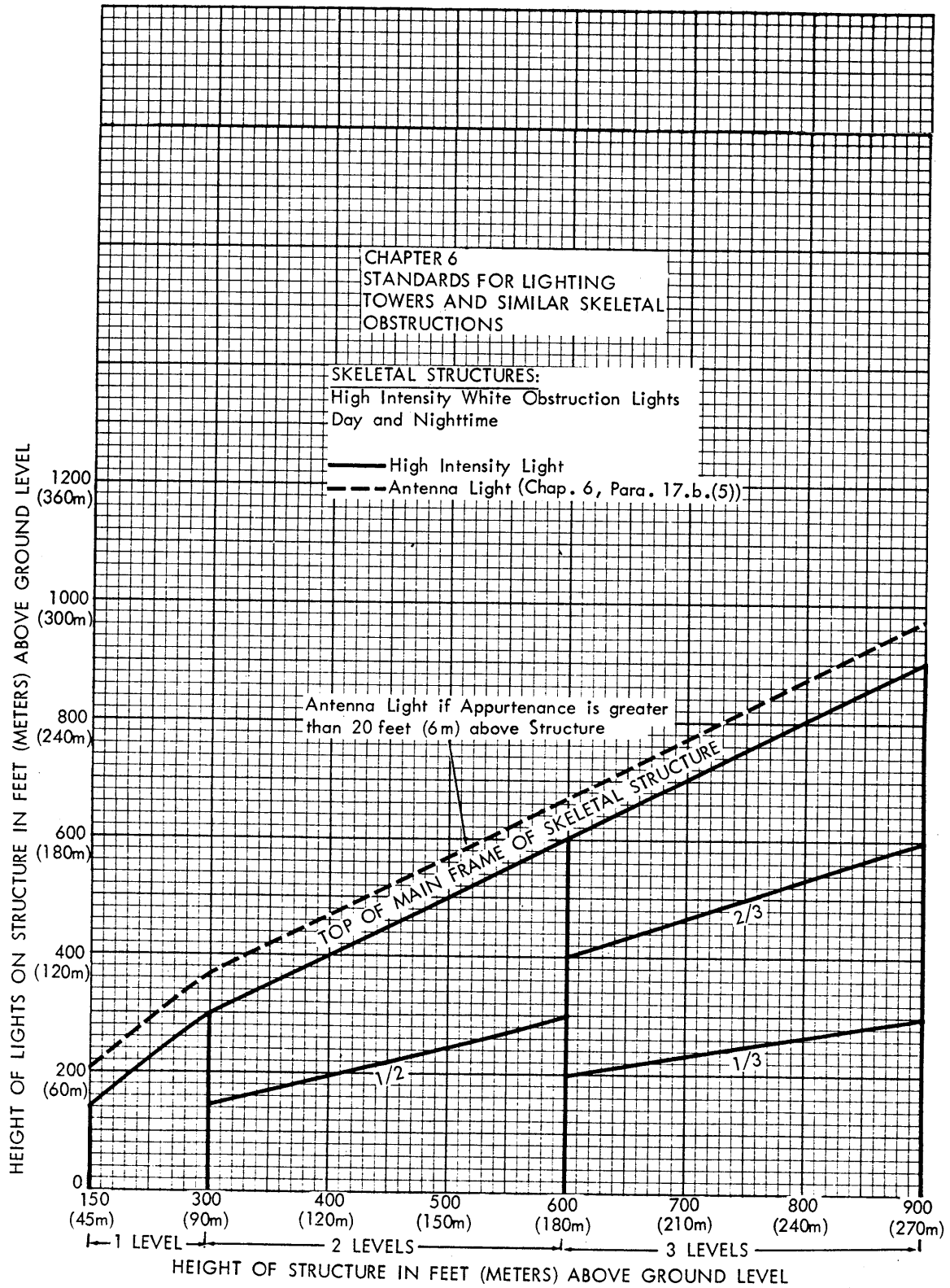

Fig. 7.

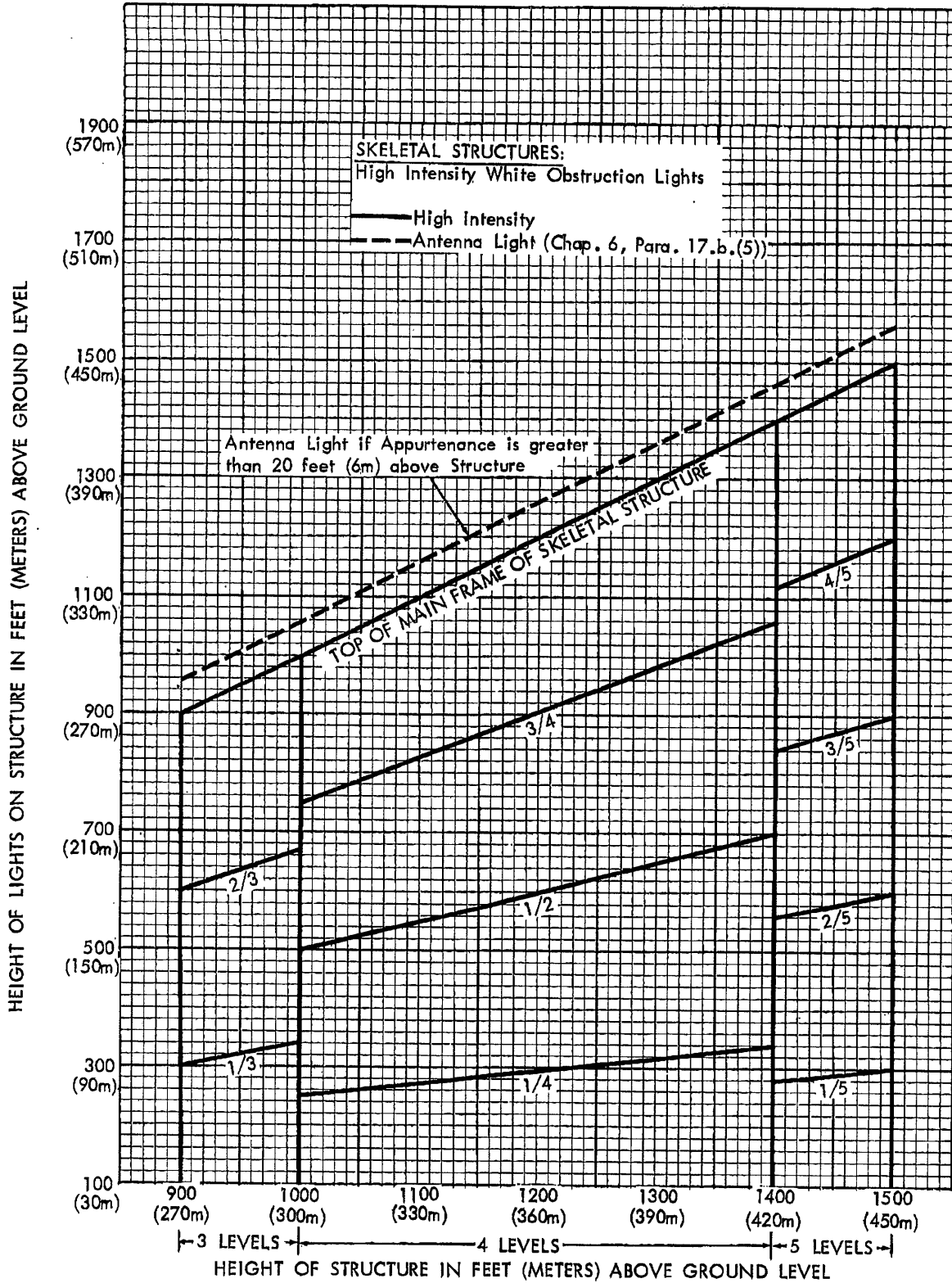

Fig. 8.

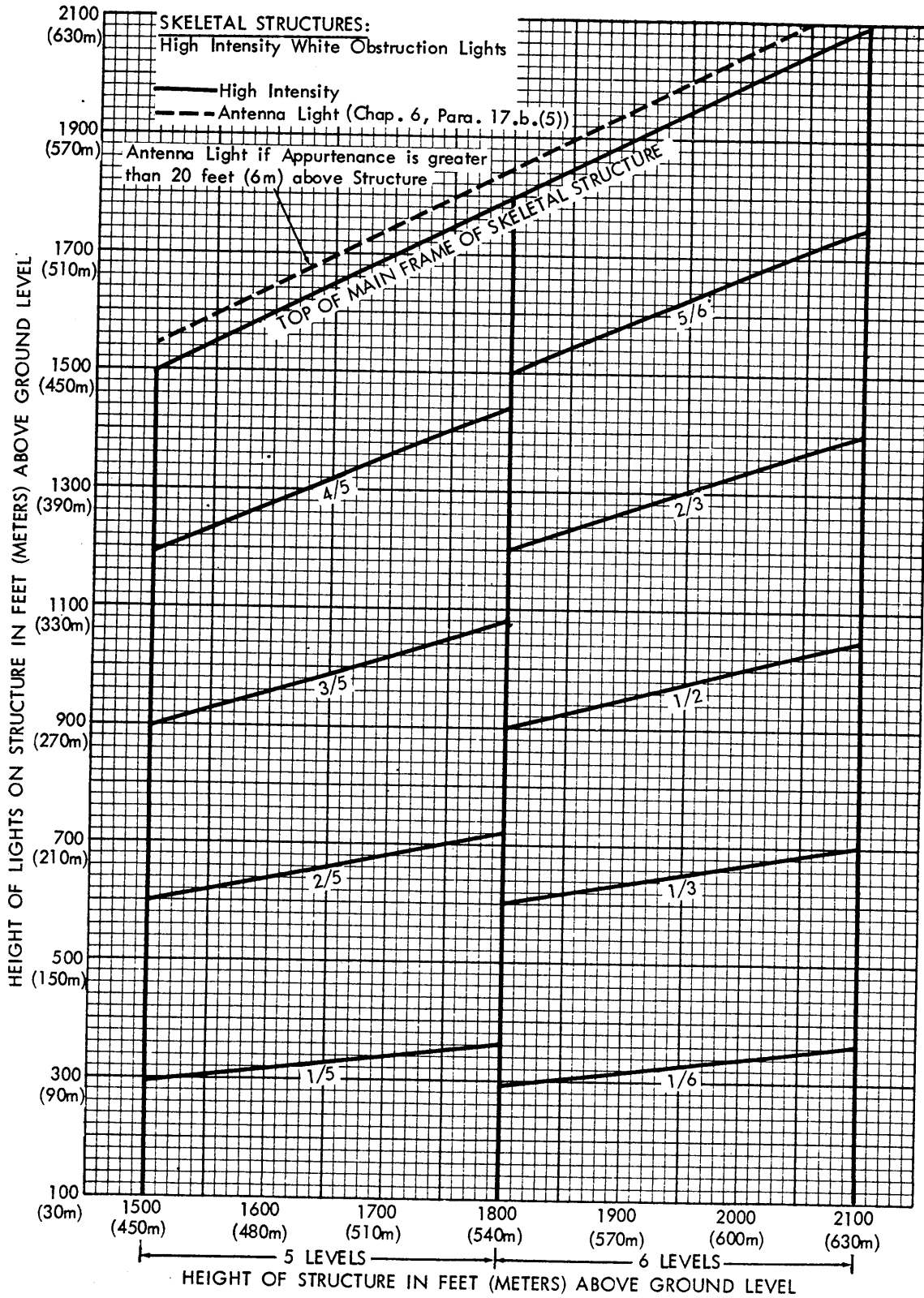

Fig. 9.

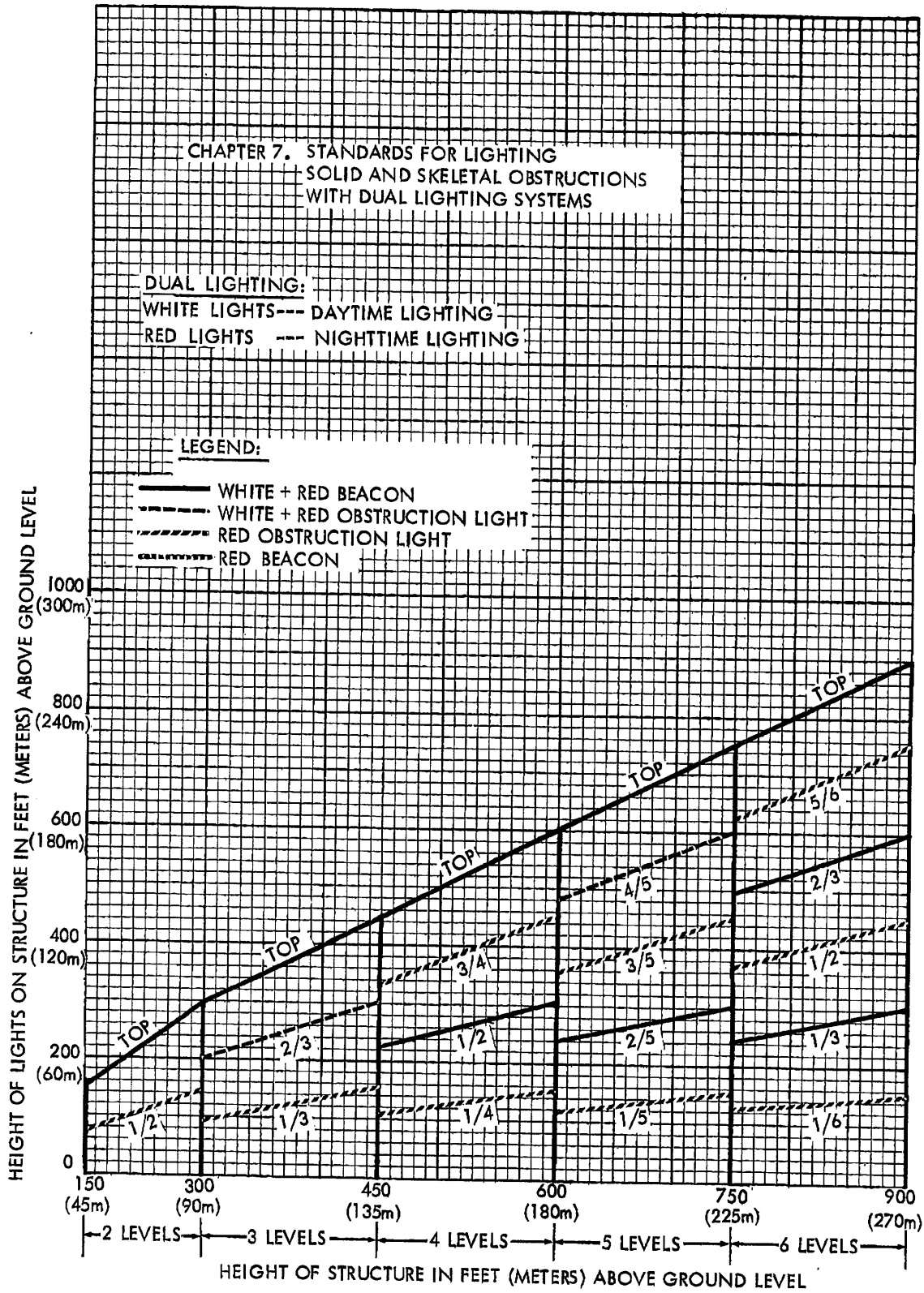

Fig. 10.

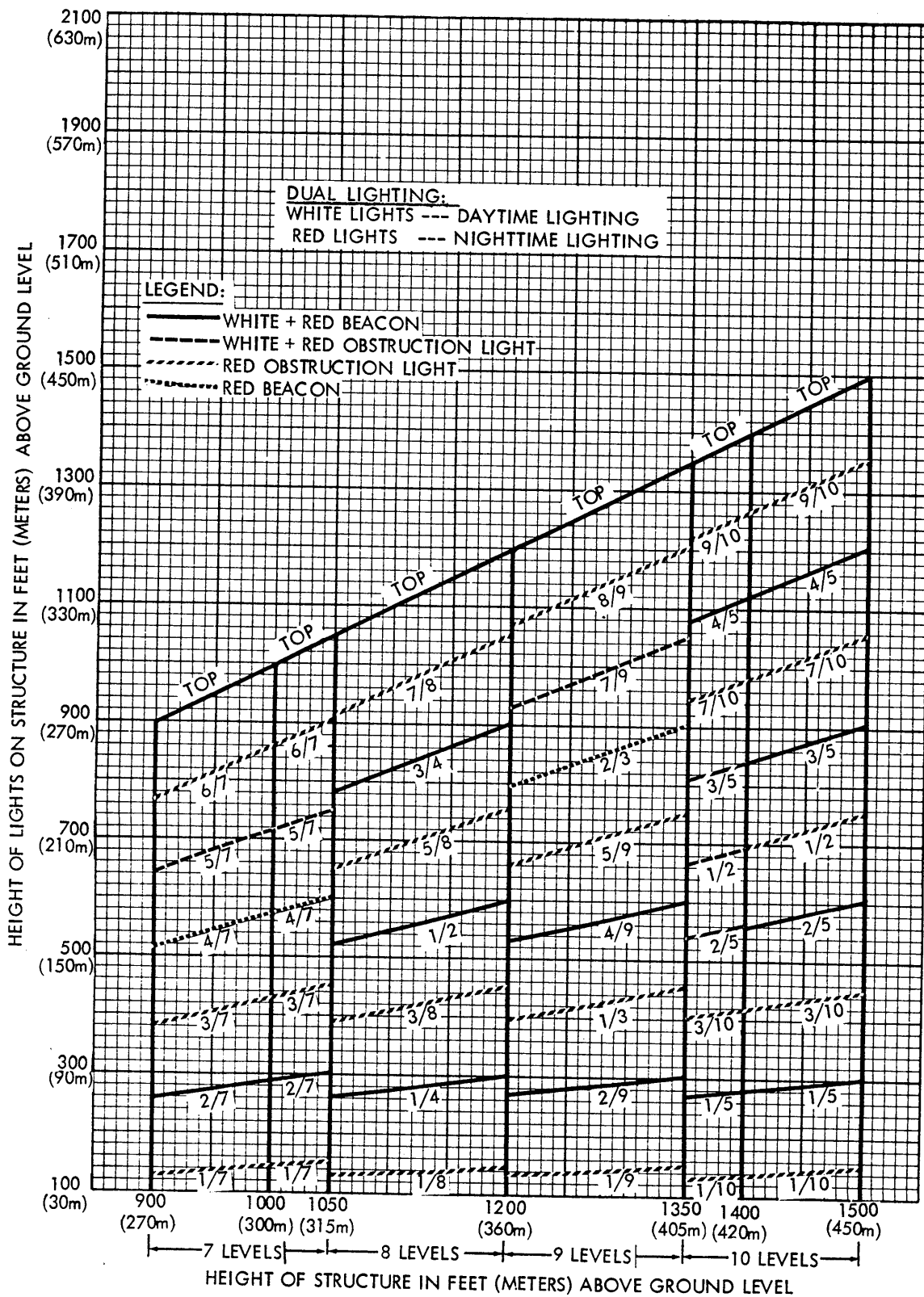

Fig. 11.

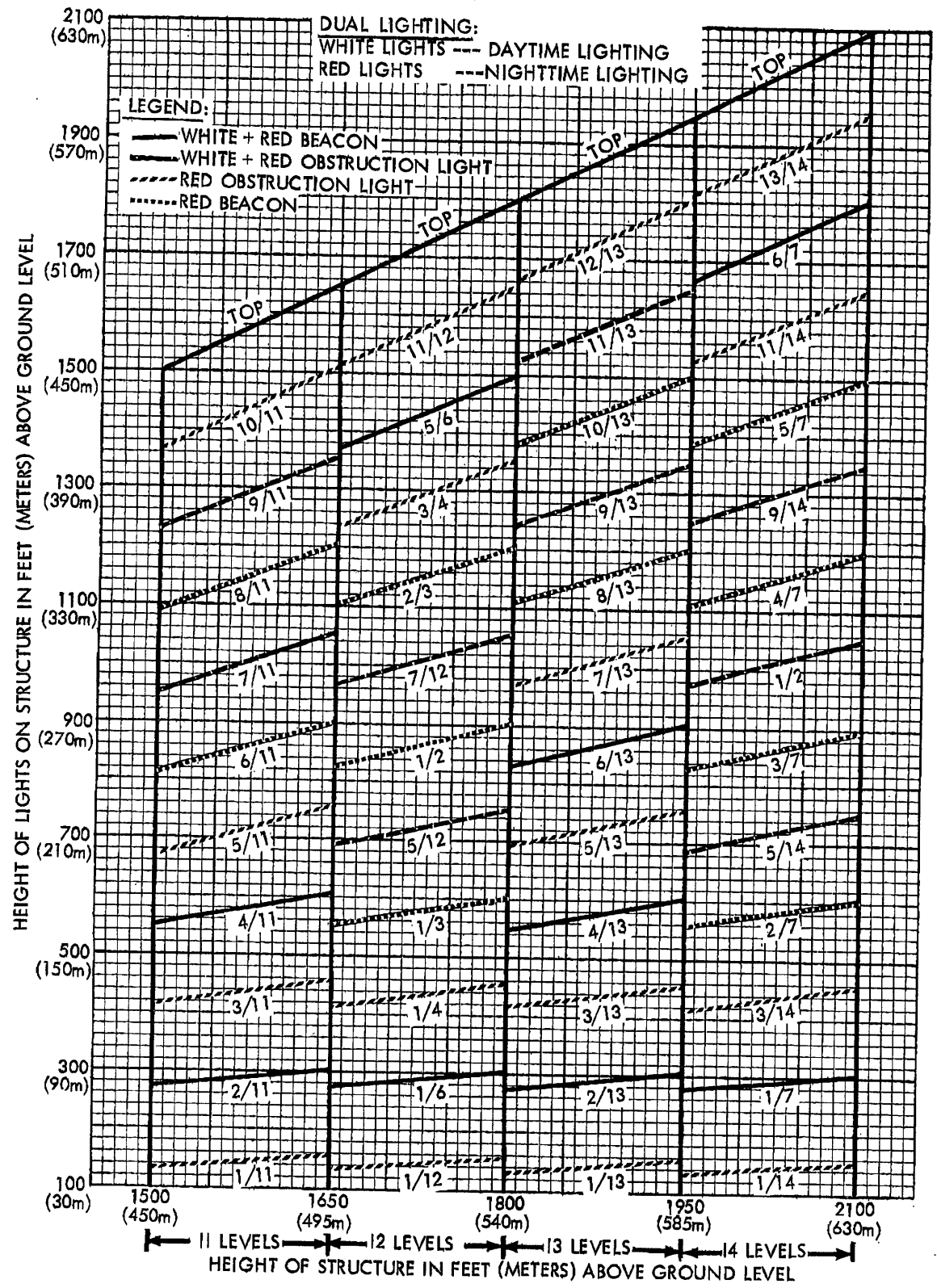

Fig. 12.